

HUGO COUPLINGS



**Huco
Precision
Couplings**

Select the coupling that meets your application requirements precisely.

Boston Gear offers a wide variety of Huco couplings including precision, beam and general purpose. Use the graph below as a quick reference guide to determine which type of coupling fits your performance and cost design envelope.

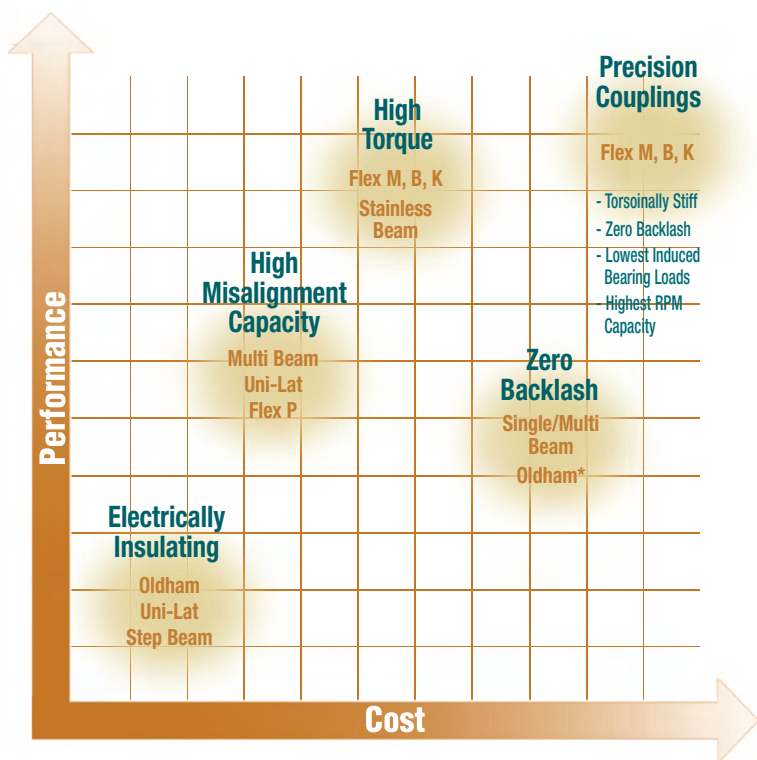

A coupling's purpose is to transfer rotational movement from one shaft to another. The reality of this function is somewhat more complicated, as flexible shaft couplings also need to compensate for misalignment between the two shafts. This ability must be balanced with the need to be pliable in the planes of misalignment while still having the torsional strength to carry out the coupling's main function.

The Compliance mechanism is the capacity for allowing relative displacement. This displacement could be due to angular misalignment, radial/parallel misalignment and axial movement. Most applications will have "some" cumulative amount.

* The Oldham coupling has the potential to wear.

Page 2 - 3 Applications
 Page 4 - 5 How To Order

Precision Couplings

Page 6 - 7 Flex B Bellows



Page 8 - 9 Flex K Large Bellows



Page 10 - 11 Flex M Disc



Beam Couplings

Page 12 - 19 Multi Beam – Six Beam



Page 20 - 23 Multi Beam – Three Beam



Page 24 - 27 Single Beam



Page 28 - 29 Step Beam



General Purpose Couplings

Page 30 - 33 Oldham



Page 34 - 37 Uni-Lat



Page 38 - 39 Flex P



Friction Clutches

Page 40 - 41 Vari-Tork



Page 42 Vari-Tork Installation

Page 43 - 45 Coupling Installation Guide

Page 46 - 55 Application Design Guide

Page 56 Bore Reducers

Description	Applications	Speeds rpm	Torque Capacity* - largest size Lbs.-Inch (Nm)	Standard Bores In. (mm)	Temp. Range °F (°C)	Max. Torsional Stiffness (Nm/rad)
Precision Bellows Coupling with excellent kinematic properties. Two types offer differing combinations of stiffness, misalignment and axial motion.	High-end servo drives, pulse generators, scanners, positioning slides, metering valves, etc.	Up to 5000 in standard form	110.6 (12.5)	1/8"-3/4" (3 - 20)	-40° to +250°F (-40° to +120°)	(2880)
Large Precision Bellows Coupling with excellent kinematic properties. Two types offer differing combinations of stiffness, misalignment and axial motion.	High-end servo drives, pulse generators, scanners, positioning slides, metering valves, etc.	Up to 5000 in standard form, up to 30000 in balanced form	4425 (500)	1/2"-2.500" (16-65)	-40° to +250°F (-40° to +120°)	(320000)
Precision Disc Coupling with excellent kinematic properties. Dynamically balanced construction. Single-stage versions make up into 'whirl' free Cardans. Two-stage versions offer short envelopes and low bearing loads.	High-end servo drives, pulse generators, scanners, positioning slides, high speed dynamometers, unsupported drive shafts, etc.	Up to 30000 in balanced form	531 (60)	1/8"-1.000" (3 - 28)	-40° to +250°F (-40° to +120°)	(12000)
Zero backlash single piece couplings. Single stage (3-beam); two stage (6-beam). Material options available for moisture and corrosion resistance.	Stepper and servo drives, encoders, general purpose light-duty power transmission applications.	Up to 5000 in standard form, up to 30000 in balanced form	1239 (140)	1/8"-1.250" (1 - 38)	-40° to +250°F (-40° to +120°)	(2245)
Zero backlash single piece couplings. More flexible than Multi-Beam but less torsionally rigid.	Stepper drives, encoders, general purpose light-duty power transmission applications.	Up to 5000 in standard form, up to 30000 in balanced form	266 (30)	1/8"-3/4" (3 - 26)	-40° to +250°F (-40° to +120°)	(19000)
Unique plastic coupling design provides an excellent combination of radial flexibility with torsional stiffness.	Encoders, tachometers, small pumps, motors and drives.	Up to 1000	221 (25)	1/8"-1/2" (3 - 12.7)	23° to 300°F (-20° to +150°)	(378)
Zero/low backlash couplings, robust design. Easy to use 3-part couplings with replaceable wear elements. Pull-apart re-engage facility for blind assemblies.	Stepper drives for most applications including positioning slides, pumps, actuators, etc.	Up to 3000	389 (44)	1/8"-1.000" (2 - 30)	23° to 140°F (-20° to +60°)	(2340)
Unique, light duty couplings with generous angular and radial misalignment compensation. Resists axial motion, can anchor unrestricted shafts and perform light push/pull duties.	Encoder, resolver, tachometers, potentiometer drives. Small positioning slides, dosing pumps, & and general light drives.	Up to 3000	106 (12)	1/8"-3/4" (3 - 22)	23° to 140°F (-20° to +60°)	(18)
Exceptional flexibility in all three directions: radial, angular and axial.	Light power drives, pumps and small generators.	Up to 3000	159 (18)	1/8"-5/8" (3 - 16)	-40° to +212°F (-40° to +100°)	(1200)
Small, user-adjustable torque limiters for concentric or in-line mounting. Operates by friction using interleaved clutch plates.	Friction clutches interrupt rotation when the load being transmitted reaches a pre-determined threshold. Used in all types of small drives to help protect personnel and equipment.	Up to 1000 slipping speed	27 (3)	1/4"-1/2" (6 - 12)	(-10° to +80°)	

* Torque capacity is the maximum continuous rated torque assuming no misalignment.

Boston Gear offers a wide variety of Huco couplings for precision industrial and commercial applications worldwide.

Selecting the right shaft coupling can be the difference between a drive system that provides the required dynamic response and one that is catastrophic. The application constraints lead engineers towards products that have different levels of torsional stiffness, vibration dampening, backlash, and low bearing loads. Huco can respond quickly with a wide variety of couplings such as general purpose, beam style, and precision couplings suitable for highly reliable applications.



Precision Couplings

Flex B Bellows, Flex K Large Bellows and Flex M Disc type couplings are ideal for use in high-end servo drives, pulse generators, scanners, X-Y positioning slides, high speed dynamometers, measuring instruments, robots, and machine tools.



Beam Couplings

Step Beam, Single Beam, Three Beam, and Six Beam couplings are available for use in stepper and servo drives, encoders, tachometers, small pumps, motors and drives and light-duty power transmission applications.



General Purpose Couplings

Oldham couplings are designed for use in stepper drives and most applications including positioning slides, pumps, actuators, etc. Uni-Lat models are ideal for encoder, resolver, tachometers, potentiometer drives, as well as small positioning slides, dosing pumps, and general light drives. Flex P units can be utilized in light power drives, pumps and small generators.



Friction Clutches

Vari-Tork™ friction clutches allow slippage when the torque being transmitted reaches a pre-determined threshold. Used in all types of small drives to help protect personnel and equipment.



How To Order

Building an Ordering Part Number is fast and easy using the Specifications and Bore Size charts on each product page. Simply select the coupling type, coupling size and two bore sizes you require (always place smaller bore first). Always include (.) in Part Number.

Ordering Number System Example: 537.20.1418

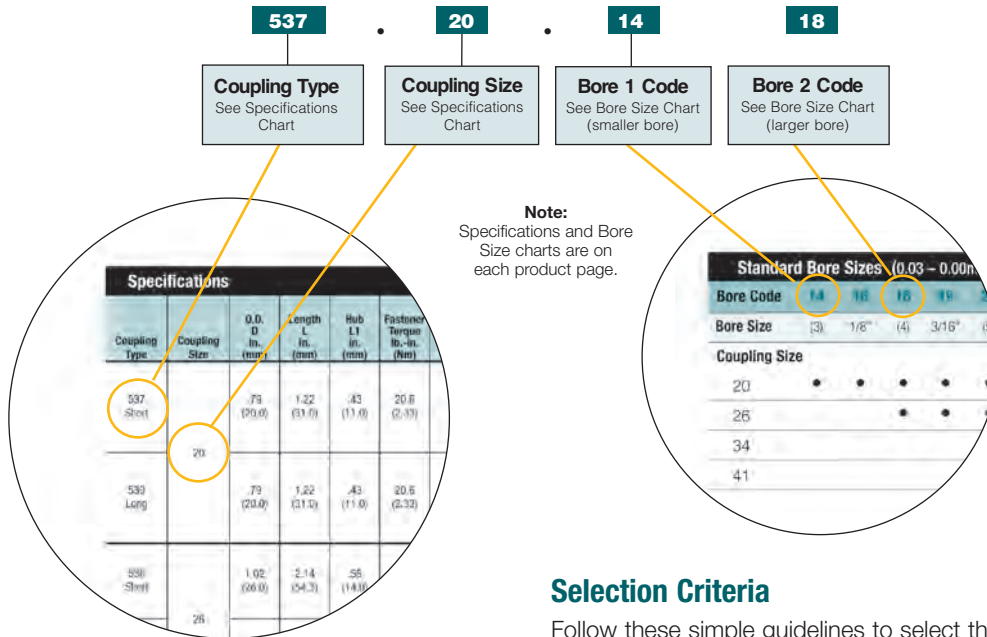

The following key factors should always be considered when specifying flexible shaft couplings:

- Torsional Stiffness
- Backlash
- Torque
- Life
- Shaft Attachment type
- Misalignment Requirements

Service Factors

- Torque capacity values shown in the coupling Specification Charts assume uniform load conditions at a constant speed with no misalignment or axial displacement. See page 48 to provide adequate service factors.
- The torque capacity of flexible couplings will reduce when acceleration is present (eg: stop/start or reverse conditions).
- The more severe the acceleration, the greater reduction in torque capacity.
- The more severe the misalignment, the greater reduction in torque capacity.
- Sliding couplings (Oldham and UniLat) are subject to a wear rate dependant on the number of cycles completed and environmental factors.

Selection Criteria

Follow these simple guidelines to select the optimal coupling choice for your particular application.

- Does the coupling provide adequate misalignment protection?
- Can it transmit the required torque?
- Can it sustain the required rotational speed?
- Will it fit in the available space envelope?
- Can it operate at the designated ambient temperature?
- Will it provide the torsional stiffness required for positional accuracy?
- Does it provide electrical isolation between the shafts?
- Will it provide the required life expectancy?
- Is axial motion or axial stiffness required?

Specifying a Keywayed Bore

To specify a keywayed bore, prefix the 2-digit bore code number with a "P" for metric keyways or an "R" for an inch keyway.

Examples:

Metric: 538.34.P28P28

In this example both bores have a keyway.

Inch: 538.34.24R36

In this example only the second bore will have a keyway.

Standard keyways are machined to two specifications:

- Bore Codes prefixed with a "P" denote a metric keyway conforming to ISO 773/774 (BS 4235 Pt. 1).
- Bore Codes prefixed with a "R" denote an inch keyway conforming to BS 46 Pt. 1.

Round & Keywayed Bore Details & Codes						
Metric mm	Inch fraction	Inch decimal	Round bore code	Metric keys key size w x h	Inch keys key size w x h	Keywayed bore code
1	–	0.0394	08	–	–	–
1.5	–	0.0591	09	–	–	–
1.588	1/16	0.0625	10	–	–	–
2	–	0.0787	11	–	–	–
2.286	–	0.0900	12	–	–	–
2.382	3/32	0.0938	13	–	–	–
3	–	0.1181	14	–	–	–
3.048	–	0.1200	15	–	–	–
3.175	1/8	0.1250	16	–	–	–
*3.969	5/32	0.1563	–	–	–	–
4	–	0.1575	18	–	–	–
4.763	3/16	0.1875	19	–	–	–
5	–	0.1969	20	–	–	–
5.556	7/32	0.2188	21	–	–	–
6	–	0.2362	22	–	–	–
6.096	–	0.2400	23	–	–	–
6.350	1/4	0.2500	24	–	–	–
7	–	0.2756	25	2 x 2	–	P25
7.144	9/32	0.2813	26	–	–	–
7.938	5/16	0.3125	27	–	1/8 x 1/8	R27
8	–	0.3150	28	2 x 2	–	P28
8.731	11/32	0.3438	29	–	1/8 x 1/8	R29
9	–	0.3543	30	3 x 3	–	P30
9.525	3/8	0.3750	31	–	1/8 x 1/8	R31
10	–	0.3937	32	3 x 3	–	P32
11	–	0.4331	33	4 x 4	–	P33
11.113	7/16	0.4375	34	–	1/8 x 1/8	R34
12	–	0.4724	35	4 x 4	–	P35
12.700	1/2	0.5000	36	–	1/8 x 1/8	R36
13	–	0.5118	37	5 x 5	–	P37
14	–	0.5512	38	5 x 5	–	P38
14.288	9/16	0.5625	39	–	3/16 x 3/16	R39
15	–	0.5906	40	5 x 5	–	P40
15.875	5/8	0.6250	41	–	3/16 x 3/16	R41
16	–	0.6299	42	5 x 5	–	P42
17	–	0.6693	43	5 x 5	–	P43
17.463	11/16	0.6875	44	–	3/16 x 3/16	R44
18	–	0.7087	45	6 x 6	–	P45
19	–	0.7480	46	6 x 6	–	P46
19.050	3/4	0.7500	47	–	3/16 x 3/16	R47
20	–	0.7874	48	6 x 6	–	P48
20.64	13/16	0.8125	48A	–	–	–
22	–	0.8661	49	6 x 6	–	P49
22.225	7/8	0.8750	50	–	1/4 x 1/4	R50
24	–	0.9449	51	8 x 7	–	P51
25	–	0.9843	52	8 x 7	–	P52
25.400	1	1.0000	53	–	1/4 x 1/4	R53
26.99	1-1/16	1.0625	53B	–	–	–
28	–	1.1024	54	8 x 7	–	P54
28.575	1-1/8	1.1250	55	–	5/16 x 1/4	R55

* Not manufactured. Nearest alternative 4mm.

Round & Keywayed Bore Details & Codes Cont.						
Metric mm	Inch fraction	Inch decimal	Round bore code	Metric keys key size w x h	Inch keys key size w x h	Keywayed bore code
30	–	1.1811	56	8 x 7	–	P56
31.750	1-1/4	1.2500	57	–	5/16 x 1/4	R57
33.34	1-5/16	1.3125	57A	–	–	–
32	–	1.2598	58	10 x 8	–	P58
34.925	1-3/8	1.3750	59	–	3/8 x 1/4	R59
35	–	1.3780	60	10 x 8	–	P60
36.51	1-7/16	1.4375	60B	–	–	–
38	–	1.4961	61	10 x 8	–	P61
38.10	1-1/2	1.5000	62	–	–	–
39.69	1-9/16	1.5625	62A	–	–	Specify on Order
40	–	1.5748	63	–	–	–
41.28	1-5/8	1.6250	64	–	–	–
42	–	1.6535	65	–	–	Specify on Order
42.86	1-11/16	1.6875	65A	–	–	–
44.45	1-3/4	1.7500	66	–	–	–
45	–	1.7717	67	–	–	Specify on Order
46.04	1-13/16	1.8125	67A	–	–	–
47.63	1-7/8	1.8750	68	–	–	–
48	–	1.8898	69	–	–	Specify on Order
49.21	1-15/16	1.9375	69A	–	–	–
50	–	1.9685	70	–	–	–
50.80	2	2.0000	71	–	–	Specify on Order
53.98	2-1/8	2.1250	72	–	–	–
55	–	2.1654	73	–	–	–
55.56	2-3/16	2.1875	73AA	–	–	Specify on Order
56	–	2.2047	73A	–	–	–
57.15	2-1/4	2.2500	74	–	–	–
60	–	2.3622	75	–	–	Specify on Order
60.33	2-3/8	2.3750	76	–	–	–
61.91	2-7/16	2.4375	76A	–	–	–
63.50	2-1/2	2.5000	77	–	–	Specify on Order
65	–	2.5591	78	–	–	–
66.68	2-5/8	2.6250	78AA	–	–	–
68.26	2-11/16	2.6875	78AB	–	–	Specify on Order
69.85	2-3/4	2.7500	78A	–	–	–
70	–	2.7559	78B	–	–	–
73.03	2-7/8	2.8750	79	–	–	Specify on Order
74.61	2-15/16	2.9375	79A	–	–	–
75	–	2.9528	80	–	–	–

Flex B | Precision Couplings

Stainless Steel Bellows Clamp Type



Typical Applications

- High-end servo drives
- Pulse generators
- Scanners
- Positioning slides
- Metering valves

General Specifications

- Temperature range: -40 to +120 Degrees C.
- Standard speed rating: 5,000 rpm maximum.
- Standard fasteners are 100% metric.

Materials & Finishes

- **Hubs:** Aluminum alloy 2014T6 and AlEco 62sn T9 clear anodised finish
- **Bellows:** Spring quality stainless steel
- **Joint Assembly:** Copper C106, heat treated zinc plate, clear passivate
- **Fasteners:** Alloy steel, black oiled

Options

- **Set screw mounting instead of clamp collar.** Consult Technical Support.
- **Stretched version (see photo) provides higher torque capacity.** Peak torque capacity values 2.5 x the long type but has reduced misalignment capacity. Consult Technical Support.
- **Keyways can be provided.** Specify an "R" bore code prefix for inch keyways and "P" for metric (Ex: 538.41.R41R41).
- **Speed ratings up to 30,000 possible depending on size.** Consult Technical Support.

Dimensions

Clamp Hubs

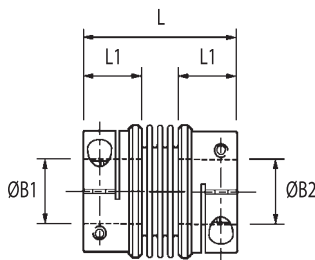

**Coupling Type
536 & 537
Short**
(precisely aligned shafts)

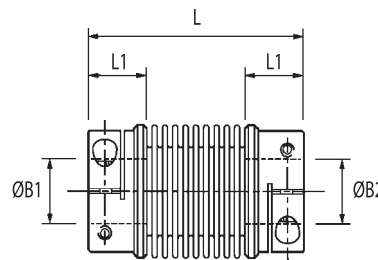

**Coupling Type
538 & 539
Long**
(greater angular offsets or axial motion)

Sizes indicated in parenthesis are metric (mm).

Standard Bore Sizes (0.03 – 0.00mm)

Bore Code	14	16	18	19	20	22	24	28	30	31	32	33	35	36	38	40	41	42	45	46	47	48
Bore Size	(3)	1/8"	(4)	3/16"	(5)	(6)	1/4"	(8)	(9)	3/8"	(10)	(11)	(12)	1/2"	(14)	(15)	5/8"	(16)	(18)	(19)	3/4"	(20)
Coupling Size																						
20	•	•	•	•	•	•	•	•														
26			•	•	•	•	•	•	•	•	•	•	•									
34						•	•	•	•	•	•	•	•	•	•	•	•	•				
41							•	•	•	•	•	•	•	•	•	•	•	•	•	•	•	•

For a complete list of bore sizes see page 5.

Visit www.bostongear.com to identify which parts are stocked items. If your bore combination is not stocked select a coupling to match your larger shaft size and select a bore reducer from page 56 to fit your smaller shaft.

Stainless Steel Bellows Clamp Type

Ordering Number System for Flex B Models Example: 537.20.1828

537

20

18

28

Coupling Type 536 or 537: Short 538 or 539: Long	Coupling Size 20, 26, 34, 41	Bore 1 Code See Bore Size Chart (smaller bore)	Bore 2 Code See Bore Size Chart (larger bore)
---	--	---	--

Order as one complete coupling part number with two bores. Include (.) in Part Number.

See page 5 for **keyworded** bores and more detailed ordering information.

Part Number Examples

Specifications																Part Number Examples		
Coupling Type	Coupling Size	O.D. D in. (mm)	Length L in. (mm)	Hub L1 in. (mm)	Fastener Torque lb.-in. (Nm)	Inertia KGM ² x10 ³	Torque* Capacity lb.-in. (Nm)	Misalignment Capacity **			Flexural Stiffness				Weight lb. (Kg)	Bore		Part Number
								Angular Degree	Radial in. (mm)	Axial in. (±mm)	Torsional Nm/Rad	Angular N/Deg	Radial N/mm	Axial N/mm		B1	B2	
537 Short	20	.79 (20.0)	1.22 (31.0)	.43 (11.0)	20.6 (2.33)	90	17.7 (2.0)	2	.002 (.06)	.014 (.35)	315	1.03	115	17.7	.035 (.016)	4mm	4mm	537.20.1818
																5mm	5mm	537.20.2020
539 Long	20	.79 (20.0)	1.78 (45.2)	.43 (11.0)	20.6 (2.33)	100	8.85 (1.0)	6	.020 (.50)	.040 (1.00)	170	0.33	6.7	7.8	.040 (.018)	6mm	6mm	537.20.2222
																8mm	8mm	537.20.2228
536 Short	26	1.02 (26.0)	1.48 (37.5)	.55 (14.0)	21.5 (2.43)	330	28.3 (3.2)	2	.020 (.06)	.014 (.36)	755	1.27	238	5.7	.075 (.034)	1/4	1/4	537.20.2424
																8mm	8mm	537.20.2828
538 Long	26	1.02 (26.0)	2.14 (54.3)	.55 (14.0)	21.5 (2.43)	380	14.2 (1.6)	6	.020 (.50)	.040 (1.00)	380	0.39	8.2	3.3	.084 (.038)	4mm	4mm	539.20.1818
																5mm	5mm	539.20.2020
536 Short	34	1.34 (34.0)	1.57 (40.0)	.55 (14.0)	21.5 (2.43)	925	66.4 (7.5)	2.5	.004 (.10)	.023 (.60)	1740	1.34	227	6.6	.123 (.056)	6mm	6mm	536.26.2222
																3/8	3/8	536.26.3131
538 Long	34	1.34 (34.0)	2.24 (57.0)	.55 (14.0)	21.5 (2.43)	1078	33.6 (3.8)	8	.040 (1.00)	.075 (1.90)	915	0.62	12.7	3.8	.139 (.063)	10mm	10mm	536.26.3232
																12mm	12mm	536.26.3535
536 Short	41	1.61 (34.0)	1.96 (49.7)	.71 (18.0)	50.0 (5.66)	2390	88.5 (10.0)	2.5	.006 (.15)	.031 (.80)	2880	1.58	144	13.1	.218 (.099)	6mm	6mm	538.26.2222
																8mm	8mm	538.26.2828
538 Long	41	1.61 (34.0)	2.81 (71.4)	.71 (18.0)	50.0 (5.66)	2660	44.3 (5.0)	8	.047 (1.20)	.098 (2.50)	1310	0.52	9.3	3.8	.236 (.107)	1/4	1/4	536.26.2431
																3/8	3/8	536.26.3131

*Torque Capacity is the maximum continuous rated torque assuming no misalignment. See page 52 for Torque Capacity Service Factors.

**Maximum misalignment values are mutually exclusive.

Flex K | Precision Couplings

Stainless Steel Large Bellows Clamp Type



Typical Applications

- High-end servo drives
- Pulse generators
- Scanners
- Positioning slides
- Metering valves

General Specifications

- Temperature range: -30 to +120 Degrees C.
- Standard speed rating: 5,000 rpm maximum.
- Standard fasteners are 100% metric.

Materials & Finishes

- **Hubs:** Aluminum alloy 2014T6 and AlEco 62sn T9 clear anodised finish. Hubs on size 66 and larger are steel.
- **Bellows:** Spring quality stainless steel
- **Fasteners:** Alloy steel, black oiled

Options

- **Keyways can be provided.** Specify an "R" bore code prefix for Inch keyways and "P" for metric (Example 554.45.R41.R41).
- **Tapered adapter/sleeve designs available.** Consult Technical Support.
- **Set screw versions available.** Specify coupling type as 550 (short version) and 551 (long version).

Dimensions

Clamp Hubs

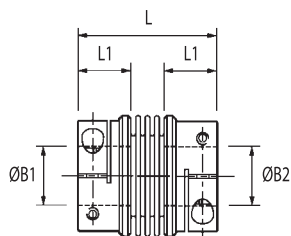

Coupling Type 554 Short
(precisely aligned shafts)

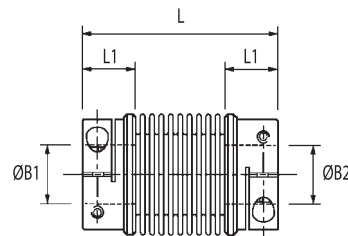

Coupling Type 555 Long
(greater angular offsets or axial motion)

Sizes indicated in parenthesis are metric (mm).

Standard Bore Sizes (0.03 – 0.00mm)

Bore Code	41	42	45	47	48	51	52	53	56	57	58	59	60	60A	62	63	64	66	67	70	71	74	76	77
Bore Size	5/8" (16)	(18)	3/4" (20)	(24)	(25)	1.00" (30)	1-1/4" (32)	1-3/8" (35)	(36)	1-1/2" (40)	1-5/8" (45)	1-3/4" (45)	(50)	2.00" (50)	2-1/4" (60)	2-3/8" (60)	2-1/2" (63)							
Coupling Size																								
45	•	•	•	•	•	•	•	•																
66	•	•	•	•	•	•	•	•	•	•	•													
90						•	•	•	•	•	•	•	•	•	•	•	•	•	•	•				
110									•	•	•	•	•	•	•	•	•	•	•	•	•	•	•	•
122												•	•	•	•	•	•	•	•	•	•	•	•	•

For a complete list of bore sizes see page 5.

Visit www.bostongear.com to identify which parts are stocked items. If your bore combination is not stocked select a coupling to match your larger shaft size and select a bore reducer from page 56 to fit your smaller shaft.

Stainless Steel Large Bellows Clamp Type

Ordering Number System for Flex K Models Example: 554.90.6267

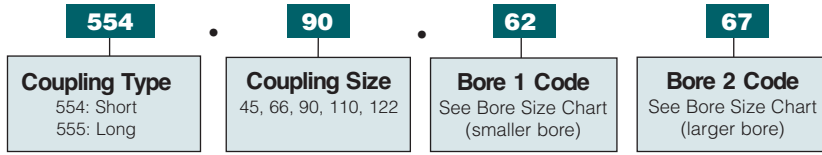

Order as one complete coupling part number with two bores. Include (.) in Part Number.

See page 5 for **keywayed** bores and more detailed ordering information.

Part Number Examples

Specifications

Coupling Type	Coupling Size	O.D. D in. (mm)	Length L in. (mm)	Hub L1 in. (mm)	Fastener Torque lb.-in. (Nm)	Inertia KGM ² X 10 ⁻⁸	Torque* Capacity lb.-in. (Nm)	Misalignment Capacity**			Flexural Stiffness			Weight lb. (Kg)	Bore		Part Number
								Angular Degree	Radial in. (mm)	Axial in. (±mm)	Torsional Nm/Rad	Radial N/mm	Axial N/mm		B1	B2	
554 Short	45	1.77 (45.0)	2.480 (63.0)	.768 (19.5)	71 (8.0)	3560	159 (18)	1.5	.008 (.20)	.020 (.5)	20,000	7790	100	.12 (.054)	5/8	5/8	554.45.4141
															3/4	3/4	554.45.4747
															7/8	7/8	554.45.5050
555 Long	45	1.77 (45.0)	2.795 (71.0)	.768 (19.5)	71 (8.0)	4560	159 (18)	2	.010 (.25)	.020 (.5)	15,000	970	85	.23 (.104)	1.000	1.000	554.45.5353
															5/8	5/8	555.45.4141
															3/4	3/4	555.45.4747
554 Short	66	2.60 (66.0)	3.110 (79.0)	1.142 (29.0)	354 (40)	31360	531 (60)	1.5	.006 (.15)	.024 (.6)	75,000	1150	90	0.86 (.390)	25mm	25mm	554.66.5252
															1.000	1.000	554.66.5353
															1.250	1.250	554.66.5757
555 Long	66	2.60 (66.0)	3.504 (89.0)	1.142 (29.0)	354 (40)	34360	531 (60)	2	.010 (.25)	.040 (1.0)	50,000	340	50	1.08 (.490)	30mm	30mm	554.66.5656
															25mm	25mm	555.66.5252
															1.000	1.000	555.66.5353
554 Short	90	3.54 (90.0)	3.976 (101.0)	1.496 (38.0)	1100 (125)	305980	1770 (200)	1.5	.008 (.20)	.020 (.5)	175,000	2020	145	4.13 (1.875)	1.500	1.500	554.90.6262
															40mm	40mm	554.90.6363
															1.750	1.750	554.90.6666
555 Long	90	3.54 (90.0)	4.449 (113.0)	1.496 (38.0)	1100 (125)	325980	1770 (200)	2	.010 (.25)	.031 (.8)	120,000	595	82	4.35 (1.975)	45mm	45mm	554.90.6767
															1.500	1.500	555.90.6262
															40mm	40mm	555.90.6363
554 Short	110	4.33 (110.0)	4.134 (105.0)	1.496 (38.0)	1100 (125)	654095	2655 (300)	1.5	.008 (.20)	.020 (.5)	502,000	2500	280	5.14 (2.33)	1.750	1.750	555.90.6666
															45mm	45mm	554.90.6767
															1.500	1.500	555.90.6262
555 Long	110	4.33 (110.0)	4.567	1.496 (38.0)	1100 (125)	674095	2655 (300)	2	.010 (.25)	.031 (.8)	285,000	460	145	5.36 (2.43)	40mm	40mm	555.90.6363
															1.750	1.750	555.90.6666
															45mm	45mm	555.90.6767
554 Short	122	4.80 (122.0)	4.409 (112.0)	1.654 (42.0)	1100 (125)	1124450	4425 (500)	1.5	.008 (.20)	.020 (.5)	690,000	6300	100	7.80 (3.54)	50mm	50mm	544.110.7070
															2.000	2.000	544.110.7171
															2.250	2.250	544.110.7474
555 Long	122	4.80 (122.0)	4.843 (123.0)	1.654 (42.0)	1100 (125)	1154450	4425 (500)	2	.010 (.25)	.040 (1.0)	320,000	1400	85	8.02 (3.64)	60mm	60mm	555.110.7575
															2.000	2.000	555.110.7171
															2.250	2.250	555.110.7474
554 Short	122	4.80 (122.0)	4.409 (112.0)	1.654 (42.0)	1100 (125)	1124450	4425 (500)	1.5	.008 (.20)	.020 (.5)	690,000	6300	100	7.80 (3.54)	2.375	2.375	554.122.7676
															65mm	65mm	554.122.7878
															2.500	2.500	554.122.7777
555 Long	122	4.80 (122.0)	4.843 (123.0)	1.654 (42.0)	1100 (125)	1154450	4425 (500)	2	.010 (.25)	.040 (1.0)	320,000	1400	85	8.02 (3.64)	2.375	2.375	555.122.7676
															65mm	65mm	555.122.7878
															2.500	2.500	555.122.7777

*Torque Capacity is the maximum continuous rated torque assuming no misalignment. See page 52 for Torque Capacity Service Factors.

**Maximum misalignment values are mutually exclusive.

Flex M Precision Couplings

Disc Coupling Clamp Type



Typical Applications

- High-end servo drives
- Pulse generators
- Scanners
- Positioning slides
- High speed dynamometers
- Unsupported drive shafts

General Specifications

- Temperature range: -40 to +120 Degrees C.
- Balanced speed ratings: Size 19-33 – 30,000 rpm
Size 41 – 20,000 rpm, Size 66 – 15,000 rpm
- Standard fasteners are 100% metric.

Materials & Finishes

- **Hubs & Spacer:** Aluminum alloy 7020T6
Clear anodised finish
- **Membranes:** Spring quality stainless steel, heat treated
- **Rivet Assembly:** Brass rivets flanked by formed steel washers – Steel, zinc plate & colour passivate
- **Fasteners:** Alloy steel, black oiled

Options

- **Set screw mounting instead of clamp collar.** Consult Technical Support.
- **Keyways can be provided.** Specify an “R” bore code prefix for inch keyways and “P” for metric (Ex: 470.41.P28P28).
- **Drive shafts can be provided.** Specify the coupling/bore size and the overall drive shaft length.
- **Single stage couplings are available in the 462 Type.** Consult Technical Support.

Dimensions

Clamp Hubs

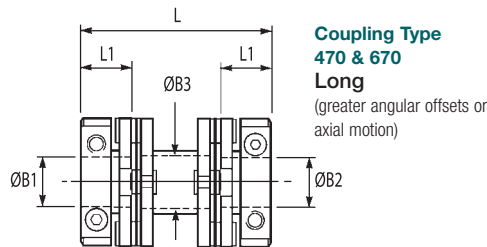
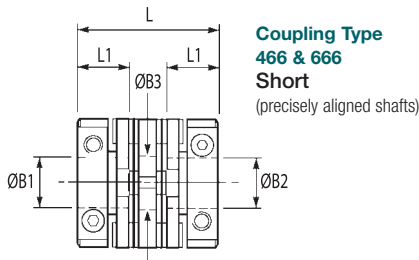

Sizes indicated in parenthesis are metric (mm).

Standard Bore Sizes (0.03 – 0.00mm)

Bore Code	14	16	18	19	20	22	24	28	31	32	35	36	38	41	42	45	46	47	48	51	52	53	54	
Bore Size	(3)	1/8"	(4)	3/16"	(5)	(6)	1/4"	(8)	3/8"	(10)	(12)	1/2"	(14)	5/8"	(16)	(18)	(19)	3/4"	(20)	(24)	(25)	1.00"	(28)	
Coupling Size																								
19	•	•																						
26			•	•	•	•	•	•	•	•														
33						•	•	•	•	•	•	•												
41							•	•	•	•	•	•	•	•	•									
52							•	•	•	•	•	•	•	•	•	•	•	•	•	•	•	•	•	•
66														•	•	•	•	•	•	•	•	•	•	•

For a complete list of bore sizes see page 5.

Visit www.bostongear.com to identify which parts are stocked items.
If your bore combination is not stocked select a coupling to match your larger shaft size and select a bore reducer from page 56 to fit your smaller shaft.

Precision Couplings | Flex M

Disc Coupling – Clamp Type

Ordering Number System for Flex M Models Example: 466.19.1622

466

19

16

22

Coupling Type

466 & 666: Short
470 & 670: Long

Coupling Size

19, 26, 33, 41, 52, 66

Bore 1 Code

See Bore Size Chart
(smaller bore)

Bore 2 Code

See Bore Size Chart
(larger bore)

Order as one complete coupling part number with two bores. Include (.) in Part Number.

See page 5 for **keywayed** bores and more detailed ordering information.

Specifications																	Part Number Examples		
Coupling Type	Coupling Size	O.D. D in. (mm)	Length L in. (mm)	Hub		Fastener Torque lb.-in. (Nm)	Inertia $KGM^2 \times 10^{-8}$	Torque* Capacity lb.-in. (Nm)	Misalignment Capacity**			Flexural Stiffness				Weight lb. (Kg)	Bore		Part Number
				L1 in. (mm)	Dia. B3 in. (mm)				Angular Degree	Radial in. (mm)	Axial in. (±mm)	Torsional Nm/Rad	Angular N/Deg	Radial N/mm	Axial N/mm		B1	B2	
466 Short	19	.76 (19.2)	1.05 (26.8)	.36 (9.2)	.29 (7.3)	11.7 (1.32)	60	8.0 (0.9)	4	.008 (0.2)	.008 (0.2)	150	0.25	14	<7	.028 (.013)	5mm	5mm	466.19.2020
		.76 (19.2)	1.35 (34.5)	.36 (9.2)	.29 (7.3)	11.7 (1.32)	60	8.0 (0.9)	4	.016 (0.4)	.008 (0.2)	145	0.3	4	<7	.030 (.014)	1/4	1/4	466.19.2424
470 Long	19	.76 (19.2)	1.35 (34.5)	.36 (9.2)	.29 (7.3)	11.7 (1.32)	60	8.0 (0.9)	4	.016 (0.4)	.008 (0.2)	145	0.3	4	<7	.030 (.014)	5mm	5mm	470.19.2020
		.76 (19.2)	1.35 (34.5)	.36 (9.2)	.29 (7.3)	11.7 (1.32)	60	8.0 (0.9)	4	.016 (0.4)	.008 (0.2)	145	0.3	4	<7	.030 (.014)	1/4	1/4	470.19.2424
466 Short	26	1.01 (25.6)	1.12 (28.4)	.39 (10)	.43 (11)	11.7 (1.32)	160	20.0 (2.3)	4	.008 (0.2)	.008 (0.2)	385	0.5	37	<7	.044 (.020)	6mm	6mm	466.26.2222
		1.01 (25.6)	1.42 (36.1)	.39 (10)	.43 (11)	11.7 (1.32)	210	20.0 (2.3)	4	.016 (0.4)	.008 (0.2)	400	0.4	7	<7	.055 (.025)	1/4	1/4	466.26.2424
470 Long	26	1.01 (25.6)	1.42 (36.1)	.39 (10)	.43 (11)	11.7 (1.32)	210	20.0 (2.3)	4	.016 (0.4)	.008 (0.2)	400	0.4	7	<7	.055 (.025)	1/4	3/8	466.26.2431
		1.01 (25.6)	1.42 (36.1)	.39 (10)	.43 (11)	11.7 (1.32)	210	20.0 (2.3)	4	.016 (0.4)	.008 (0.2)	400	0.4	7	<7	.055 (.025)	8mm	8mm	466.26.2828
466 Short	33	1.32 (33.5)	1.58 (40.1)	.55 (14)	.56 (14.1)	21.5 (2.43)	730	50.0 (5.6)	3	.008 (0.2)	.008 (0.2)	935	1	48	<8	.112 (.051)	10mm	10mm	466.26.3232
		1.32 (33.5)	2.00 (50.8)	.55 (14)	.56 (14.1)	21.5 (2.43)	760	50.0 (5.6)	3	.016 (0.4)	.008 (0.2)	980	1.2	13	<8	.121 (.055)	1/2	1/2	466.26.3232
470 Long	33	1.32 (33.5)	2.00 (50.8)	.55 (14)	.56 (14.1)	21.5 (2.43)	760	50.0 (5.6)	3	.016 (0.4)	.008 (0.2)	980	1.2	13	<8	.121 (.055)	3/8	3/8	466.33.3131
		1.32 (33.5)	2.00 (50.8)	.55 (14)	.56 (14.1)	21.5 (2.43)	760	50.0 (5.6)	3	.016 (0.4)	.008 (0.2)	980	1.2	13	<8	.121 (.055)	3/8	1/2	466.33.3136
466 Short	41	1.63 (41.5)	1.91 (48.5)	.67 (17)	.69 (17.5)	50.0 (5.66)	2220	100.0 (11.3)	2	.008 (0.2)	.008 (0.2)	1980	2	100	<8	.220 (.100)	10mm	10mm	466.33.3232
		1.63 (41.5)	2.37 (60.1)	.67 (17)	.69 (17.5)	50.0 (5.66)	2220	100.0 (11.3)	2	.016 (0.4)	.008 (0.2)	2020	2	25	<8	.240 (.109)	11mm	11mm	466.33.3333
470 Long	41	1.63 (41.5)	2.37 (60.1)	.67 (17)	.69 (17.5)	50.0 (5.66)	2220	100.0 (11.3)	2	.016 (0.4)	.008 (0.2)	2020	2	25	<8	.240 (.109)	12mm	12mm	466.33.3535
		1.63 (41.5)	2.37 (60.1)	.67 (17)	.69 (17.5)	50.0 (5.66)	2220	100.0 (11.3)	2	.016 (0.4)	.008 (0.2)	2020	2	25	<8	.240 (.109)	1/2	1/2	466.33.3636
666 Short	52	2.05 (52.0)	2.39 (60.8)	.90 (22.9)	.87 (22.0)	100.9 (11.4)	7470	265.5 (30.0)	2	.008 (0.2)	.008 (0.2)	4800	5	313	<9	.458 (.208)	3/8	3/8	466.41.2436
		2.05 (52.0)	3.08 (78.1)	.90 (22.9)	.87 (22.0)	100.9 (11.4)	8870	265.5 (30.0)	2	.016 (0.4)	.008 (0.2)	4800	5	313	<9	.544 (.247)	3/8	3/8	466.41.3131
670 Long	52	2.05 (52.0)	3.08 (78.1)	.90 (22.9)	.87 (22.0)	100.9 (11.4)	8870	265.5 (30.0)	2	.016 (0.4)	.008 (0.2)	4800	5	313	<9	.544 (.247)	1/2	5/8	466.41.3641
		2.05 (52.0)	3.08 (78.1)	.90 (22.9)	.87 (22.0)	100.9 (11.4)	8870	265.5 (30.0)	2	.016 (0.4)	.008 (0.2)	4800	5	313	<9	.544 (.247)	5/8	5/8	466.41.4141
666 Short	66	2.60 (66)	2.74 (69.6)	1.02 (26)	1.12 (28.7)	100.0 (11.4)	19300	531.0 (60)	2	.008 (0.2)	.008 (0.2)	12000	23	379	<9	.787 (.357)	5/8	5/8	666.52.3131
		2.60 (66)	3.57 (90.7)	1.02 (26)	1.18 (30.2)	100.0 (11.4)	24320	531.0 (60)	2	.016 (0.4)	.008 (0.2)	12000	23	93	<9	.978 (.444)	1/2	5/8	666.52.3641
670 Long	66	2.60 (66)	3.57 (90.7)	1.02 (26)	1.18 (30.2)	100.0 (11.4)	24320	531.0 (60)	2	.016 (0.4)	.008 (0.2)	12000	23	93	<9	.978 (.444)	5/8	5/8	666.52.4141
		2.60 (66)	3.57 (90.7)	1.02 (26)	1.18 (30.2)	100.0 (11.4)	24320	531.0 (60)	2	.016 (0.4)	.008 (0.2)	12000	23	93	<9	.978 (.444)	16mm	16mm	666.52.4242

*Torque Capacity is the maximum continuous rated torque assuming no misalignment. See page 52 for Torque Capacity Service Factors.

**Maximum misalignment values are mutually exclusive.

Multi-Beam | Six Beam Couplings

Stainless Non-Relieved Clamp Type



Typical Applications

- Stepper and servo drives
- Encoders
- General purpose light-duty power transmission

General Specifications

- Temperature range: -40 to +140 Degrees C.
- Standard speed rating: 5,000 rpm maximum.
- Standard fasteners are 100% metric.

Materials & Finishes

- **Couplings:** Stainless Steel 303 S31
- **Fasteners:** Stainless Steel

Options

- Available in set screw style, Coupling Type 702 (Ex: 702.51.4848)
- Keyways available in set screw style only. Consult Technical Support.
- High speed options available. Consult Technical Support.

Dimensions

Clamp Hubs

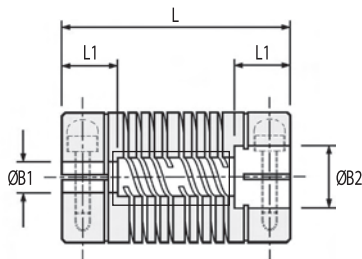

Coupling Type
703
6-Beam Non-Relieved

• = B1 only • = B1 & B2

Sizes indicated in parenthesis are metric (mm).

Standard Bore Sizes / 6-Beam Non-Relieved (0.03 – 0.00mm)

Bore Code	11	14	16	18	19	20	22	24	28	31	32	35	36	38	41	42	45	46	47	48	51	52	53	54	56	
Bore Size	(2)	(3)	1/8"	(4)	3/16"	(5)	(6)	1/4"	(8)	3/8"	(10)	(12)	1/2"	(14)	5/8"	(16)	(18)	(19)	3/4"	(20)	(24)	(25)	1.00"	(28)	(30)	
Coupling Size																										
09	•	•	•	•	•																					
13		•	•	•	•	•	•	•																		
16		•	•	•	•	•	•	•	•																	
19					•	•	•	•	•	•	•															
25						•	•	•	•	•	•	•	•													
32										•	•	•	•	•	•	•										
38										•	•	•	•	•	•	•	•	•	•	•						
44										•	•	•	•	•	•	•	•	•	•	•	•					
51											•	•	•	•	•	•	•	•	•	•	•	•	•	•		
57											•	•	•	•	•	•	•	•	•	•	•	•	•	•	•	•

For a complete list of bore sizes see page 5.

Visit www.bostongear.com to identify which parts are stocked items.
If your bore combination is not stocked select a coupling to match your larger shaft size and select a bore reducer from page 56 to fit your smaller shaft.

Six Beam Couplings | Multi-Beam

Stainless Non-Relieved – Clamp Type

Ordering Number System for Multi-Beam Models Example: 703.25.2232

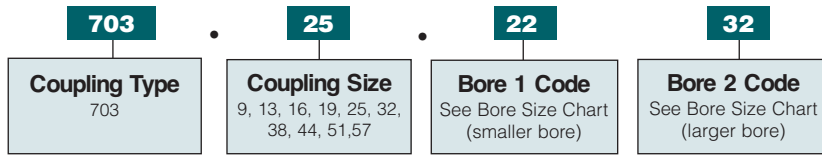

Order as one complete coupling part number with two bores. Include (.) in Part Number.

See page 5 for **keywayed** bores and more detailed ordering information.

Specifications										Part Number Examples	
Coupling Type	Coupling Size	O.D. D in. (mm)	Length L in. (mm)	Hub L1 in. (mm)	Torque* Capacity lb.-in. (Nm)	Misalignment Capacity**			Bore		Part Number
						Angular Degree	Radial in. (mm)	Weight Lb (kg)	B1	B2	
703	09	.37 (9.5)	.77 (19.6)	.21 (5.3)	13.3 (1.5)	3	.005 (.12)	.015 (.007)	4mm	4mm	703.09.1818
									3/16	3/16	703.09.1919
703	13	.50 (12.7)	1.00 (25.4)	.26 (6.5)	26.5 (3.0)	5	.007 (.17)	.036 (.016)	5mm	5mm	703.13.2020
									6mm	6mm	703.13.2222
									1/4	1/4	703.13.2424
703	16	.63 (15.9)	1.00 (25.4)	.26 (6.5)	44.3 (5.0)	5	.008 (.20)	.057 (.026)	6mm	6mm	703.16.2222
									6mm	8mm	703.16.2228
									8mm	8mm	703.16.2828
703	19	.75 (19.1)	1.10 (28.0)	.26 (6.5)	70.8 (8.0)	7	.010 (.25)	.090 (.041)	6mm	10mm	703.19.2232
									1/4	1/4	703.19.2424
									3/8	3/8	703.19.3131
703	25	1.00 (25.4)	1.50 (38.1)	.43 (11.0)	141.6 (16.0)	7	.015 (.38)	.227 (.103)	8mm	8mm	703.25.2828
									8mm	10mm	703.25.2832
									1/4	3/8	703.25.2431
									1/4	1/2	703.25.2436
									3/8	3/8	703.25.3131
									10mm	10mm	703.25.3232
703	32	1.25 (31.8)	2.25 (57.2)	.63 (16.0)	221.3 (25.0)	7	.020 (.50)	.602 (.273)	10mm	10mm	703.32.3232
									12mm	12mm	703.32.3535
									3/8	1/2	703.32.3136
703	38	1.50 (38.1)	2.63 (66.7)	.71 (18.0)	318 (36.0)	7	.024 (.60)	.932 (.423)	1/2	1/2	703.38.3636
									1/2	5/8	703.38.3641
									13mm	13mm	703.38.3737
									14mm	14mm	703.38.3838
									5/8	5/8	703.38.4141
703	44	1.75 (44.5)	3.00 (76.2)	.79 (20.0)	425 (48.0)	7	.031 (.80)	1.477 (.670)	16mm	16mm	703.38.4242
									5/8	3/4	703.44.4147
									5/8	7/8	703.44.4150
									3/4	3/4	703.44.4747
703	51	2.00 (50.8)	3.75 (95.3)	.89 (25.0)	646 (73.0)	7	.035 (.90)	2.330 (1.057)	20mm	20mm	703.44.4848
									19mm	19mm	703.51.4646
									3/4	3/4	703.51.4747
									3/4	7/8	703.51.4750
									3/4	1	703.51.4753
									22mm	22mm	703.51.4949
									7/8	7/8	703.51.5050
									7/8	1	703.51.5053
									24mm	24mm	703.51.5151
25mm	25mm	703.51.5252									
703	57	2.25 (57.2)	5.12 (130.0)	1.26 (32.0)	903 (102)	7	.037 (.95)	4.048 (1.836)	1	1	703.51.5353
									30mm	30mm	703.57.5656
									1.125	1.125	703.57.5555

*Torque Capacity is the maximum continuous rated torque assuming no misalignment. See page 52 for Torque Capacity Service Factors.

**Maximum misalignment values are mutually exclusive.

Multi-Beam | Six Beam Couplings

Stainless Relieved Clamp Type



Typical Applications

- Stepper and servo drives
- Encoders
- General purpose light-duty power transmission

General Specifications

- Temperature range: -40 to +140 Degrees C.
- Standard speed rating: 5,000 rpm maximum.
- Standard fasteners are 100% metric.

Materials & Finishes

- **Couplings:** Stainless Steel 303 S31
- **Fasteners:** Stainless Steel

Options

- Available in set screw style **Type 722** (Ex: 722.51.4848).
- Keyways available in set screw style **only**. Consult Technical Support.
- High speed options. Consult Technical Support.

Dimensions

Clamp Hubs

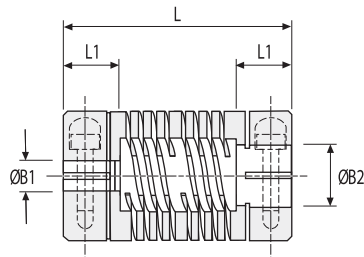

Coupling Type
723
6-Beam Relieved

• = B1 only • = B1 & B2

Sizes indicated in parenthesis are metric (mm).

Standard Bore Sizes / 6-Beam Relieved (0.03 – 0.00mm)

Bore Code	11	14	16	18	19	20	22	24	28	31	32	35	36	38	41	42	45	46	47	48	51	52	53	54	56
Bore Size	(2)	(3)	1/8" (4)	3/16" (5)	(6)	(6)	1/4" (8)	(8)	3/8" (10)	(12)	(12)	1/2" (14)	(14)	5/8" (16)	(18)	(18)	(19)	3/4" (20)	(24)	(25)	1.00" (28)	(30)	(30)	(30)	(30)

Coupling Size

09	•	•	•	•	•																					
13		•	•	•	•	•	•	•																		
16		•	•	•	•	•	•	•	•																	
19					•	•	•	•	•	•	•															
25						•	•	•	•	•	•	•	•													
32									•	•	•	•	•	•	•	•										
38									•	•	•	•	•	•	•	•	•	•	•	•						
44										•	•	•	•	•	•	•	•	•	•	•	•					
51											•	•	•	•	•	•	•	•	•	•	•	•	•	•	•	•
57												•	•	•	•	•	•	•	•	•	•	•	•	•	•	•

For a complete list of bore sizes see page 5.

Visit www.bostongear.com to identify which parts are stocked items. If your bore combination is not stocked select a coupling to match your larger shaft size and select a bore reducer from page 56 to fit your smaller shaft.

Six Beam Couplings | Multi-Beam

Stainless Relieved Clamp Collar Type

Ordering Number System for Multi-Beam Models Example: 723.19.1928

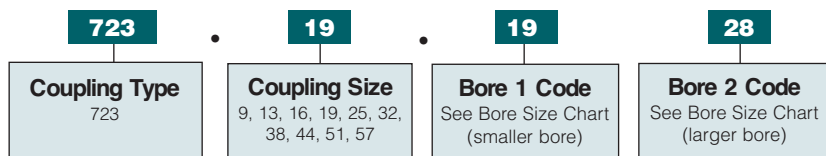

Order as one complete coupling part number with two bores. Include (.) in Part Number.

See page 5 for **keywayed** bores and more detailed ordering information.

Specifications									Part Number Examples		
Coupling Type	Coupling Size	O.D. D in. (mm)	Length L in. (mm)	Hub L1 in. (mm)	Torque* Capacity lb.-in. (Nm)	Misalignment Capacity**		Weight Lb (kg)	Bore		Part Number
						Angular Degree	Radial in. (mm)		B1	B2	
723	09	.37 (9.5)	.77 (19.6)	.21 (5.3)	7.9 (9)	3	.005 (.12)	.015 (.007)	3mm	3mm	723.09.1414
									1/8	1/8	723.09.1616
723	13	.50 (12.7)	1.00 (25.4)	.26 (6.5)	16.8 (1.9)	5	.007 (.17)	.032 (.014)	3/16	3/16	723.13.1919
									6mm	6mm	723.13.2222
									1/4	1/4	723.13.2424
723	16	.63 (15.9)	1.00 (25.4)	.26 (6.5)	30.1 (3.4)	5	.008 (.20)	.050 (.023)	4mm	4mm	723.16.1818
									5mm	5mm	723.16.2020
									8mm	8mm	723.16.2828
723	19	.75 (19.1)	1.10 (28.0)	.26 (6.5)	42.5 (4.8)	7	.010 (.25)	.079 (.036)	5mm	6mm	723.19.2022
									6mm	6mm	723.19.2222
									6mm	8mm	723.19.2028
									6mm	10mm	723.19.2232
									1/4	1/4	723.19.2424
									3/8	3/8	723.19.3131
723	25	1.00 (25.4)	1.50 (38.1)	.43 (11.0)	88.5 (10.0)	7	.015 (.38)	.205 (.093)	8mm	8mm	723.25.2828
									8mm	10mm	723.25.2832
									1/4	3/8	723.25.2431
									1/4	1/2	723.25.2436
									3/8	3/8	723.25.3131
									10mm	10mm	723.25.3232
723	32	1.25 (31.8)	2.25 (57.2)	.63 (16.0)	115 (13.0)	7	.020 (.50)	.573 (.260)	1/2	1/2	723.25.3636
									12mm	12mm	723.32.3535
									3/8	1/2	723.32.3136
723	38	1.50 (38.1)	2.63 (66.7)	.71 (18.0)	177 (20.0)	7	.024 (.60)	.838 (.380)	1/2	1/2	723.38.3636
									1/2	5/8	723.38.3641
									13mm	13mm	723.38.3737
									14mm	14mm	723.38.3838
									5/8	5/8	723.38.4141
									16mm	16mm	723.38.4242
723	44	1.75 (44.5)	3.00 (76.2)	.79 (20.0)	239 (27.0)	7	.031 (.80)	1.369 (.621)	5/8	3/4	723.44.4147
									5/8	7/8	723.44.4150
									3/4	3/4	723.44.4747
									20mm	20mm	723.44.4848
723	51	2.00 (50.8)	3.75 (95.3)	.89 (25.0)	372 (37.0)	7	.035 (.90)	2.065 (.937)	19mm	19mm	723.51.4646
									3/4	3/4	723.51.4747
									3/4	7/8	723.51.4750
									3/4	1.00	723.51.4753
									22mm	22mm	723.51.4949
									7/8	7/8	723.51.5050
									7/8	1.00	723.51.5053
									24mm	24mm	723.51.5151
									25mm	25mm	723.51.5252
1.00	1.00	723.51.5353									
723	57	2.25 (57.2)	5.12 (130.0)	1.26 (32.0)	442.5 (50)	7	.037 (.95)	3.435 (1.558)	30mm	30mm	723.57.5656
									1.125	1.125	723.57.5555

*Torque Capacity is the maximum continuous rated torque assuming no misalignment. See page 52 for Torque Capacity Service Factors.

**Maximum misalignment values are mutually exclusive.

Multi-Beam | Six Beam Couplings

Aluminum Non-Relieved Clamp Collar Type



Typical Applications

- Stepper and servo drives
- Encoders
- General purpose light-duty power transmission

General Specifications

- Temperature range: -40 to +120 Degrees C.
- Standard speed rating: 5,000 rpm maximum.
- Standard fasteners are 100% metric.

Materials & Finishes

- **Couplings:** Aluminum L 168
- **Fasteners:** Alloy steel, black oiled

Options

- Available in set screw style **Type 702** (Ex: 702.51.4949).
- **Keyways available in set screw style only.** Consult Technical Support.
- **High speed options.** Consult Technical Support.

Dimensions

Clamp Hubs

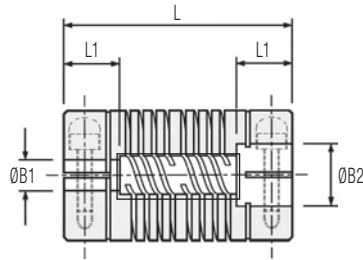

Coupling Type
707
6-Beam Non-Relieved

• = B1 only • = B1 & B2

Sizes indicated in parenthesis are metric (mm).

Standard Bore Sizes / 6-Beam Non-Relieved (0.03 – 0.00mm)

Bore Code	11	14	16	18	19	20	22	24	28	31	32	35	36	38	41	42	45	46	47	48	51	52	53	54	56	
Bore Size	(2)	(3)	1/8"	(4)	3/16"	(5)	(6)	1/4"	(8)	3/8"	(10)	(12)	1/2"	(14)	5/8"	(16)	(18)	(19)	3/4"	(20)	(24)	(25)	1.00"	(28)	(30)	
Coupling Size																										
09	•	•	•	•	•																					
13		•	•	•	•	•	•	•																		
16		•	•	•	•	•	•	•	•																	
19					•	•	•	•	•	•	•															
25						•	•	•	•	•	•	•	•													
32									•	•	•	•	•	•	•	•										
38									•	•	•	•	•	•	•	•	•	•	•	•						
44										•	•	•	•	•	•	•	•	•	•	•	•					
51											•	•	•	•	•	•	•	•	•	•	•	•	•	•	•	•
57												•	•	•	•	•	•	•	•	•	•	•	•	•	•	•

For a complete list of bore sizes see page 5.

Visit www.bostongear.com to identify which parts are stocked items.
If your bore combination is not stocked select a coupling to match your larger shaft size and select a bore reducer from page 56 to fit your smaller shaft.

Six Beam Couplings | Multi-Beam

Aluminum Non-Relieved Clamp Collar Type

Ordering Number System for Multi-Beam Models Example: 707.25.2032

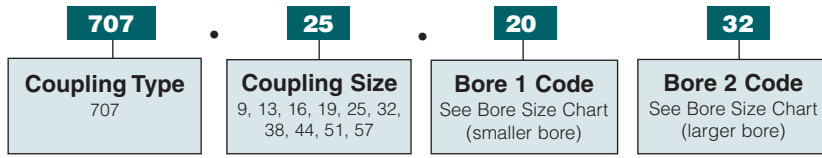

Order as one complete coupling part number with two bores. Include (.) in Part Number.

See page 5 for **keywayed** bores and more detailed ordering information.

Specifications										Part Number Examples		
Coupling Type	Coupling Size	O.D. D in. (mm)	Length L in. (mm)	Hub L1 in. (mm)	Torque* Capacity lb.-in. (Nm)	Misalignment Capacity**		Weight Lb (kg)	Bore		Part Number	
						Angular Degree	Radial in. (mm)		B1	B2		
707	09	.37 (9.5)	.77 (19.6)	.21 (5.3)	8.85 (1.0)	3	.005 (.12)	.006 (.0028)	4mm	4mm	707.09.1818	
									3/16	3/16	707.09.1919	
707	13	.50 (12.7)	.90 (22.9)	.26 (6.5)	17.7 (2.0)	5	.007 (.17)	.012 (.0055)	5mm	5mm	707.13.2020	
									6mm	6mm	707.13.2222	
707	16	.63 (15.9)	1.00 (25.4)	.26 (6.5)	30.1 (3.4)	5	.008 (.20)	.021 (.010)	1/4	1/4	707.13.2424	
									6mm	6mm	707.16.2222	
707	19	.75 (19.1)	1.04 (26.5)	.26 (6.5)	46.9 (5.3)	7	.010 (.25)	.031 (.014)	6mm	8mm	707.16.2228	
									8mm	8mm	707.16.2828	
707	25	1.00 (25.4)	1.50 (38.1)	.43 (11.0)	88.5 (10.0)	7	.015 (.38)	.081 (.037)	6mm	10mm	707.19.2232	
									1/4	1/4	707.19.2424	
707	32	1.25 (31.8)	2.25 (57.2)	.63 (16.0)	133 (15.0)	7	.020 (.50)	.215 (.097)	3/8	3/8	707.19.3131	
									8mm	8mm	707.25.2828	
707	38	1.50 (38.1)	2.63 (66.7)	.71 (18.0)	195 (22.0)	7	.024 (.60)	.344 (.156)	8mm	10mm	707.25.2832	
									1/4	3/8	707.25.2431	
707	44	1.75 (44.5)	3.00 (76.2)	.79 (20.0)	265 (30.0)	7	.031 (.80)	.536 (.243)	1/4	1/2	707.25.2436	
									3/8	3/8	707.25.3131	
707	51	2.00 (50.8)	3.75 (95.3)	.89 (25.0)	354 (40.0)	7	.035 (.90)	.842 (.382)	10mm	10mm	707.25.3232	
									1/2	1/2	707.25.3636	
707	57	2.25 (57.2)	5.12 (130.0)	1.26 (32.0)	487 (55.0)	7	.037 (.95)	1.437 (.652)	12mm	12mm	707.32.3232	
									3/8	1/2	707.32.3136	
707	57	2.25 (57.2)	5.12 (130.0)	1.26 (32.0)	487 (55.0)	7	.037 (.95)	1.437 (.652)	1/2	1/2	707.38.3636	
									1/2	5/8	707.38.3641	
707	57	2.25 (57.2)	5.12 (130.0)	1.26 (32.0)	487 (55.0)	7	.037 (.95)	1.437 (.652)	13mm	13mm	707.38.3737	
									14mm	14mm	707.38.3838	
707	57	2.25 (57.2)	5.12 (130.0)	1.26 (32.0)	487 (55.0)	7	.037 (.95)	1.437 (.652)	5/8	5/8	707.38.4141	
									16mm	16mm	707.38.4242	
707	57	2.25 (57.2)	5.12 (130.0)	1.26 (32.0)	487 (55.0)	7	.037 (.95)	1.437 (.652)	5/8	3/4	707.44.4147	
									5/8	7/8	707.44.4150	
707	57	2.25 (57.2)	5.12 (130.0)	1.26 (32.0)	487 (55.0)	7	.037 (.95)	1.437 (.652)	3/4	3/4	707.44.4747	
									20mm	20mm	707.44.4848	
707	57	2.25 (57.2)	5.12 (130.0)	1.26 (32.0)	487 (55.0)	7	.037 (.95)	1.437 (.652)	19mm	19mm	707.51.4646	
									3/4	3/4	707.51.4747	
707	57	2.25 (57.2)	5.12 (130.0)	1.26 (32.0)	487 (55.0)	7	.037 (.95)	1.437 (.652)	3/4	7/8	707.51.4750	
									3/4	1.00	707.51.4753	
707	57	2.25 (57.2)	5.12 (130.0)	1.26 (32.0)	487 (55.0)	7	.037 (.95)	1.437 (.652)	22mm	22mm	707.51.4949	
									7/8	7/8	707.51.5050	
707	57	2.25 (57.2)	5.12 (130.0)	1.26 (32.0)	487 (55.0)	7	.037 (.95)	1.437 (.652)	7/8	1.00	707.51.5053	
									24mm	24mm	707.51.5151	
707	57	2.25 (57.2)	5.12 (130.0)	1.26 (32.0)	487 (55.0)	7	.037 (.95)	1.437 (.652)	25mm	25mm	707.51.5252	
									1.00	1.00	707.51.5353	
707	57	2.25 (57.2)	5.12 (130.0)	1.26 (32.0)	487 (55.0)	7	.037 (.95)	1.437 (.652)	30mm	30mm	707.57.5656	
									1.125	1.125	707.57.5555	

*Torque Capacity is the maximum continuous rated torque assuming no misalignment. See page 52 for Torque Capacity Service Factors.

**Maximum misalignment values are mutually exclusive.

Multi-Beam | Six Beam Couplings

Aluminum Relieved Clamp Collar Type



Typical Applications

- Stepper and servo drives
- Encoders
- General purpose light-duty power transmission

General Specifications

- Temperature range: -40 to +120 Degrees C.
- Standard speed rating: 5,000 rpm maximum.
- Standard fasteners are 100% metric.

Materials & Finishes

- **Couplings:** Aluminum L 168
- **Fasteners:** Alloy steel, black oiled

Options

- Available in set screw style **Type 702** (Ex: 702.51.4949).
- **Keyways available in set screw style only.** Consult Technical Support.
- **High speed options.** Consult Technical Support.

Dimensions

Clamp Hubs

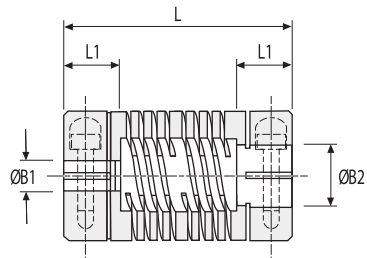

Coupling Type
727
6-Beam Relieved

• = B1 only • = B1 & B2

Sizes indicated in parenthesis are metric (mm).

Standard Bore Sizes / 6-Beam Relieved (0.03 – 0.00mm)

Bore Code	11	14	16	18	19	20	22	24	28	31	32	35	36	38	41	42	45	46	47	48	51	52	53	54	56	
Bore Size	(2)	(3)	1/8"	(4)	3/16"	(5)	(6)	1/4"	(8)	3/8"	(10)	(12)	1/2"	(14)	5/8"	(16)	(18)	(19)	3/4"	(20)	(24)	(25)	1.00"	(28)	(30)	
Coupling Size																										
09	•	•	•	•	•																					
13		•	•	•	•	•	•	•																		
16		•	•	•	•	•	•	•	•																	
19					•	•	•	•	•	•	•															
25						•	•	•	•	•	•	•	•													
32									•	•	•	•	•	•	•	•										
38									•	•	•	•	•	•	•	•	•	•	•	•						
44									•	•	•	•	•	•	•	•	•	•	•	•	•					
51										•	•	•	•	•	•	•	•	•	•	•	•	•	•	•	•	•
57											•	•	•	•	•	•	•	•	•	•	•	•	•	•	•	•

For a complete list of bore sizes see page 5.

Visit www.bostongear.com to identify which parts are stocked items. If your bore combination is not stocked select a coupling to match your larger shaft size and select a bore reducer from page 56 to fit your smaller shaft.

Six Beam Couplings | Multi-Beam

Aluminum Relieved Clamp Collar Type

Ordering Number System for Multi-Beam Models Example: 727.38.2842

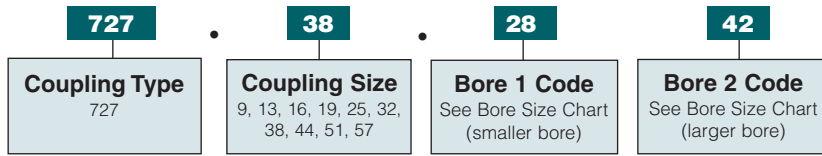

Order as one complete coupling part number with two bores. Include (.) in Part Number.

See page 5 for **keywayed** bores and more detailed ordering information.

Specifications										Part Number Examples		
Coupling Type	Coupling Size	O.D. D in. (mm)	Length L in. (mm)	Hub L1 in. (mm)	Torque* Capacity lb.-in. (Nm)	Misalignment Capacity**		Weight Lb (kg)	Bore		Part Number	
						Angular Degree	Radial in. (mm)		B1	B2		
727	09	.37 (9.5)	.77 (19.6)	.21 (5.3)	5.3 (.6)	3	.005 (.12)	.006 (.0029)	3mm	3mm	727.09.1414	
									1/8	1/8	727.09.1616	
727	13	.50 (12.7)	.90 (22.9)	.26 (6.5)	11.5 (1.3)	5	.007 (.17)	.011 (.005)	3/16	3/16	727.13.1919	
									6mm	6mm	727.13.2222	
									1/4	1/4	727.13.2424	
727	16	.63 (15.9)	1.00 (25.4)	.26 (6.5)	17.7 (2.0)	5	.008 (.20)	.019 (.0085)	4mm	4mm	727.16.1818	
									5mm	5mm	727.16.2020	
									8mm	8mm	727.16.2828	
									5mm	6mm	727.19.2022	
727	19	.75 (19.1)	1.04 (26.5)	.26 (6.5)	26.6 (3.0)	7	.010 (.25)	.027 (.012)	6mm	6mm	727.19.2222	
									6mm	8mm	727.19.2228	
									6mm	10mm	727.19.2232	
									1/4	1/4	727.19.2424	
									3/8	3/8	727.19.3131	
727	25	1.00 (25.4)	1.50 (38.1)	.43 (11.0)	44.3 (5.0)	7	.015 (.38)	.074 (.033)	8mm	8mm	727.25.2828	
									8mm	10mm	727.25.2832	
									1/4	3/8	727.25.2431	
									1/4	1/2	727.25.2436	
									3/8	3/8	727.25.3131	
									10mm	10mm	727.25.3232	
									1/2	1/2	727.25.3636	
727	32	1.25 (31.8)	2.25 (57.2)	.63 (16.0)	62.0 (7.0)	7	.020 (.50)	.205 (.093)	10mm	10mm	727.32.3232	
									12mm	12mm	727.32.3535	
									3/8	1/2	727.32.3136	
727	38	1.50 (38.1)	2.63 (66.7)	.71 (18.0)	97.4 (11.0)	7	.024 (.60)	.311 (.141)	1/2	1/2	727.38.3636	
									1/2	5/8	727.38.3641	
									13mm	13mm	727.38.3737	
									14mm	14mm	727.38.3838	
									5/8	5/8	727.38.4141	
									16mm	16mm	727.38.4242	
727	44	1.75 (44.5)	3.00 (76.2)	.79 (20.0)	133 (15.0)	7	.031 (.80)	.498 (.226)	5/8	3/4	727.44.4147	
									5/8	7/8	727.44.4150	
									3/4	3/4	727.44.4747	
									20mm	20mm	727.44.4848	
727	51	2.00 (50.8)	3.75 (95.3)	.89 (25.0)	177 (20.0)	7	.035 (.90)	.750 (.340)	19mm	19mm	727.51.4646	
									3/4	3/4	727.51.4747	
									3/4	7/8	727.51.4750	
									3/4	1.00	727.51.4753	
									22mm	22mm	727.51.4949	
									7/8	7/8	727.51.5050	
									7/8	1.00	727.51.5053	
									24mm	24mm	727.51.5151	
									25mm	25mm	727.51.5252	
1.00	1.00	727.51.5353										
727	57	2.25 (57.2)	5.12 (130.0)	1.26 (32.0)	248 (28.0)	7	.037 (.95)	1.228 (.557)	30mm	30mm	727.57.5656	
									1.125	1.125	727.57.5555	

*Torque Capacity is the maximum continuous rated torque assuming no misalignment. See page 52 for Torque Capacity Service Factors.

**Maximum misalignment values are mutually exclusive.

Multi-Beam | Three Beam Couplings

Stainless Relieved Set Screw and Clamp Type



Typical Applications

- Stepper and servo drives
- Encoders
- General purpose light-duty power transmission

General Specifications

- Temperature range: -40 to +120 Degrees C.
- Standard speed rating: 5,000 rpm maximum.
- Standard fasteners are 100% metric.

Materials & Finishes

- **Couplings:** Stainless Steel 303 S31
- **Fasteners:** Stainless Steel

Options

- **Keyways available in set screw style only.** Consult Technical Support.
- **High speed options.** Consult Technical Support.

Dimensions

Set Screw Hubs

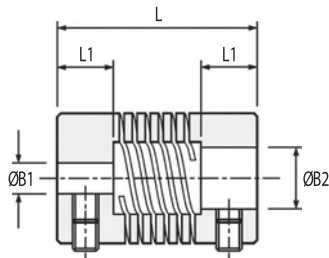

Coupling Type
720
3-Beam Relieved

Clamp Hubs

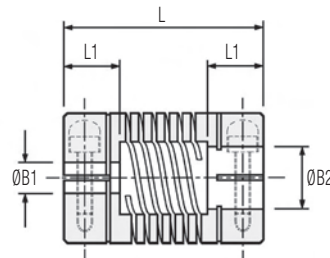

Coupling Type
721
3-Beam Relieved

• = B1 only • = B1 & B2

Sizes indicated in parenthesis are metric (mm).

Standard Bore Sizes / 3-Beam (0.03 – 0.00mm)															
Bore Code	8	11	14	16	18	19	20	22	24	28	31	32	35	38	
Bore Size	(1)	(2)	(3)	1/8"	(4)	3/16"	(5)	(6)	1/4"	(8)	3/8"	(10)	(12)	1/2"	(14)
Coupling Size															
06	•	•	•												
09		•	•	•											
13			•	•	•	•	•								
16			•	•	•	•	•	•	•						
19					•	•	•	•	•	•					
25							•	•	•	•	•	•			
32								•	•	•	•	•	•	•	•

For a complete list of bore sizes see page 5.

Visit www.bostongear.com to identify which parts are stocked items. If your bore combination is not stocked select a coupling to match your larger shaft size and select a bore reducer from page 56 to fit your smaller shaft.

Three Beam Couplings | Multi-Beam

Stainless Relieved Set Screw and Clamp Type

Ordering Number System for Multi-Beam Models Example: 720.25.2024

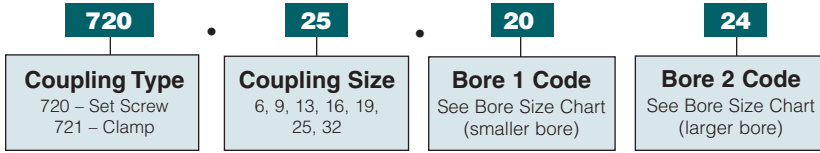

Order as one complete coupling part number with two bores. Include (.) in Part Number.

See page 5 for **keywayed** bores and more detailed ordering information.

Specifications										Part Number Examples			
Coupling Type	Coupling Size	O.D. D in. (mm)	Length L in. (mm)	Hub L1 in. (mm)	Torque* Capacity lb.-in. (Nm)	Misalignment Capacity**		Weight Lb (kg)	Bore		Set Screw Part Number	Clamp Part Number	
						Angular Degree	Radial in. (mm)		B1	B2			
720 or 721	06	.25 (6.4)	.50 (12.7)	.13 (3.2)	4.0 (.45)	3	.003 (.07)	.005 (.002)	1mm	2mm	720.06.0811	721.06.0811	
									2mm	3mm	720.06.1111	721.06.1111	
									3mm	3mm	720.06.1414	721.06.1414	
720 or 721	09	.38 (9.5)	.56 (14.2)	.18 (4.5)	4.4 (.50)	3	.004 (.10)	.013 (.006)	3mm	3mm	720.09.1414	721.09.1414	
									1/8	1/8	720.09.1616	721.09.1616	
720 or 721	13	.50 (12.7)	.75 (19.1)	.24 (6.0)	8.9 (1.0)	5	.005 (.127)	.031 (.014)	4mm	4mm	720.13.1818	721.13.1818	
									3/16	3/16	720.13.1919	721.13.1919	
									5mm	5mm	720.13.2020	721.13.2020	
720 or 721	16	.63 (15.9)	.80 (20.3)	.26 (6.5)	16.0 (1.8)	5	.005 (.127)	.053 (.024)	4mm	4mm	720.16.1818	721.16.1818	
									3/16	3/16	720.16.1919	721.16.1919	
									5mm	5mm	720.16.2020	721.16.2020	
									6mm	6mm	720.16.2222	721.16.2222	
720 or 721	19	.75 (19.1)	.90 (22.9)	.26 (6.5)	23.9 (2.7)	5	.005 (.127)	.086 (.039)	1/4	1/4	720.16.2424	721.16.2424	
									5mm	6mm	720.19.2022	721.19.2022	
									6mm	6mm	720.19.2222	721.19.2222	
									6mm	8mm	720.19.2228	721.19.2228	
720 or 721	25	1.00 (25.4)	1.25 (31.8)	.35 (9.0)	53.1 (6.0)	5	.005 (.127)	.214 (.097)	1/4	1/4	720.19.2424	721.19.2424	
									8mm	8mm	720.19.2828	721.19.2828	
									6mm	6mm	720.25.2222	721.25.2222	
									8mm	8mm	720.25.2828	721.25.2828	
720 or 721	32	1.25 (31.8)	1.75 (44.5)	.47 (12.0)	88.5 (10.0)	5	.005 (.127)	.480 (.218)	8mm	10mm	720.25.2832	721.25.2832	
									8mm	10mm	720.25.2832	721.25.2832	
									12mm	12mm	720.25.2832	721.25.2832	
									12mm	12mm	720.32.3232	721.32.3232	
									12mm	12mm	720.32.3535	721.32.3535	
									13mm	13mm	720.32.3737	721.32.3737	
720 or 721	32	1.25 (31.8)	1.75 (44.5)	.47 (12.0)	88.5 (10.0)	5	.005 (.127)	.480 (.218)	1/4	1/2	720.25.2431	721.25.2431	
									3/8	3/8	720.25.3131	721.25.3131	
									10mm	10mm	720.25.3232	721.25.3232	
									10mm	10mm	720.25.3232	721.25.3232	
720 or 721	32	1.25 (31.8)	1.75 (44.5)	.47 (12.0)	88.5 (10.0)	5	.005 (.127)	.480 (.218)	8mm	8mm	720.25.2832	721.25.2832	
									10mm	10mm	720.32.2828	721.32.2828	
									10mm	10mm	720.32.3232	721.32.3232	
									12mm	12mm	720.32.3535	721.32.3535	
									13mm	13mm	720.32.3737	721.32.3737	
									1/4	1/2	720.32.2436	721.32.2436	
720 or 721	32	1.25 (31.8)	1.75 (44.5)	.47 (12.0)	88.5 (10.0)	5	.005 (.127)	.480 (.218)	3/8	1/2	720.32.3136	721.32.3136	
									1/2	1/2	720.32.3636	721.32.3636	
720 or 721	32	1.25 (31.8)	1.75 (44.5)	.47 (12.0)	88.5 (10.0)	5	.005 (.127)	.480 (.218)	1/2	1/2	720.32.3636	721.32.3636	
									14mm	14mm	720.32.3838	721.32.3838	

*Torque Capacity is the maximum continuous rated torque assuming no misalignment. See page 52 for Torque Capacity Service Factors.

**Maximum misalignment values are mutually exclusive.

Multi-Beam | Three Beam Couplings

Aluminum Relieved Set Screw and Clamp Type



Typical Applications

- Stepper and servo drives
- Encoders
- General purpose light-duty power transmission

General Specifications

- Temperature range: -40 to +140 Degrees C.
- Standard speed rating: 5,000 rpm maximum.
- Standard fasteners are 100% metric.

Materials & Finishes

- **Couplings:** Aluminum L 168
- **Fasteners:** Alloy steel, black oiled

Options

- **Keyways available in set screw style only.** Consult Technical Support.
- **High speed options.** Consult Technical Support.

Dimensions

Set Screw Hubs

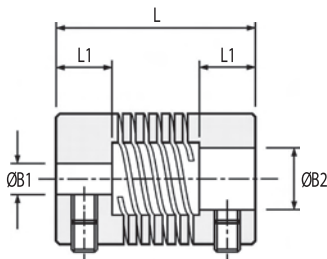

Coupling Type
724
3-Beam Relieved

Clamp Hubs

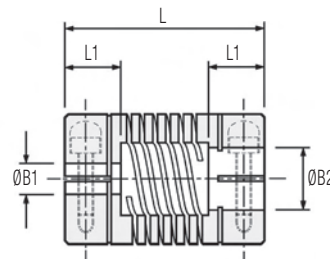

Coupling Type
725
3-Beam Relieved

• = B1 only • = B1 & B2

Sizes indicated in parenthesis are metric (mm).

Standard Bore Sizes / 3-Beam (0.03 – 0.00mm)															
Bore Code	8	11	14	16	18	19	20	22	24	28	31	32	35	36	38
Bore Size	(1)	(2)	(3)	1/8"	(4)	3/16"	(5)	(6)	1/4"	(8)	3/8"	(10)	(12)	1/2"	(14)
Coupling Size															
09		•	•	•											
13			•	•	•	•	•								
16			•	•	•	•	•	•	•						
19					•	•	•	•	•	•					
25							•	•	•	•	•	•			
32								•	•	•	•	•	•	•	•

For a complete list of bore sizes see page 5.

Visit www.bostongear.com to identify which parts are stocked items.
If your bore combination is not stocked select a coupling to match your larger shaft size and select a bore reducer from page 56 to fit your smaller shaft.

Three Beam Couplings | Multi-Beam

Aluminum Relieved Set Screw and Clamp Type

Ordering Number System for Multi-Beam Models Example: 724.16.1420

724	16	14	20
Coupling Type 724 – Set Screw 725 – Clamp	Coupling Size 9, 13, 16, 19, 25, 32	Bore 1 Code See Bore Size Chart (smaller bore)	Bore 2 Code See Bore Size Chart (larger bore)

Order as one complete coupling part number with two bores. Include (.) in Part Number.

See page 5 for **keywayed** bores and more detailed ordering information.

Specifications										Part Number Examples		
Coupling Type	Coupling Size	O.D. D in. (mm)	Length L in. (mm)	Hub L1 in. (mm)	Torque* Capacity lb.-in. (Nm)	Misalignment Capacity**		Weight Lb (kg)	Bore		Set Screw Part Number	Clamp Part Number
						Angular Degree	Radial in. (mm)		B1	B2		
724 or 725	09	.38 (9.5)	.56 (14.2)	.18 (4.5)	3.5 (.40)	3	.004 (.10)	.005 (.002)	3mm	3mm	724.09.1414	725.09.1414
									1/8	1/8	724.09.1616	725.09.1616
724 or 725	13	.50 (12.7)	.75 (19.1)	.24 (6.0)	8.0 (.90)	5	.005 (.127)	.011 (.005)	4mm	4mm	724.13.1818	725.13.1818
									3/16	3/16	724.13.1919	725.13.1919
									5mm	5mm	724.13.2020	725.13.2020
724 or 725	16	.63 (15.9)	.80 (20.3)	.26 (6.5)	13.3 (1.5)	5	.005 (.127)	.020 (.009)	4mm	4mm	724.16.1818	725.16.1818
									3/16	3/16	724.16.1919	725.16.1919
									5mm	5mm	724.16.2020	725.16.2020
									6mm	6mm	724.16.2222	725.16.2222
									1/4	1/4	724.16.2424	725.16.2424
724 or 725	19	.75 (19.1)	.90 (22.9)	.26 (6.5)	22.1 (2.5)	5	.005 (.127)	.033 (.015)	5mm	6mm	724.19.2022	725.19.2022
									6mm	6mm	724.19.2222	725.19.2222
									6mm	8mm	724.19.2228	725.19.2228
									1/4	1/4	724.19.2424	725.19.2424
									8mm	8mm	724.19.2828	725.19.2828
724 or 725	25	1.00 (25.4)	1.25 (31.8)	.35 (9.0)	35.4 (4.0)	5	.005 (.127)	.082 (.037)	6mm	6mm	724.25.2222	725.25.2222
									8mm	8mm	724.25.2828	725.25.2828
									8mm	10mm	724.25.2832	725.25.2832
									1/4	3/8	724.25.2431	725.25.2431
									3/8	3/8	724.25.3131	725.25.3131
724 or 725	32	1.25 (31.8)	1.75 (44.5)	.47 (12.0)	53.1 (6.0)	5	.005 (.127)	.181 (.082)	10mm	10mm	724.25.3232	725.25.3232
									8mm	8mm	724.32.2828	725.32.2828
									10mm	10mm	724.32.3232	725.32.3232
									12mm	12mm	724.32.3535	725.32.3535
									13mm	13mm	724.32.3737	725.32.3737
									1/4	1/2	724.32.2436	725.32.2436
									3/8	1/2	724.32.3136	725.32.3136
1/2	1/2	724.32.3636	725.32.3636									
14mm	14mm	724.32.3838	725.32.3838									

*Torque Capacity is the maximum continuous rated torque assuming no misalignment. See page 52 for Torque Capacity Service Factors.

**Maximum misalignment values are mutually exclusive.

Single-Beam | Beam Couplings

Aluminum Relieved Set Screw Type



Typical Applications

- Stepper drives
- Encoders
- General purpose light-duty power transmission

General Specifications

- Temperature range: -40 to +120 Degrees C.
- Standard speed rating: 5,000 rpm maximum.
- Standard fasteners are 100% metric.

Materials & Finishes

- **Couplings:** Aluminum L 168 or better
- **Fasteners:** Alloy steel, black oiled

Options

- **Keyways can be provided.** Consult Technical Support.

Dimensions

Set Screw Hubs

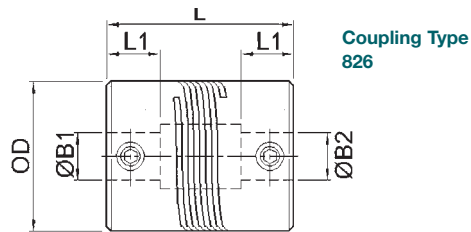

Coupling Type 826

• = B1 only • = B1 & B2

Sizes indicated in parenthesis are metric (mm).

Standard Bore Sizes (0.03 – 0.00mm)																						
Bore Code	14	16	18	19	20	22	24	27	28	30	31	32	35	36	38	40	41	42	47	48	52	53
Bore Size	(3)	1/8"	(4)	3/16"	(5)	(6)	1/4"	5/16"	(8)	(9)	3/8"	(10)	(12)	1/2"	(14)	(15)	5/8"	(16)	3/4"	(20)	(24)	(25)
Coupling Size																						
16	•	•	•	•	•	•	•															
19			•	•	•	•	•		•													
25					•	•	•	•	•	•	•	•										
32						•	•	•	•	•	•	•	•	•	•	•	•	•				
38											•	•	•	•	•	•	•	•				
50															•	•	•	•	•	•	•	•

For a complete list of bore sizes see page 5.

Visit www.bostongear.com to identify which parts are stocked items. If your bore combination is not stocked select a coupling to match your larger shaft size and select a bore reducer from page 56 to fit your smaller shaft.

Beam Couplings | Single-Beam

Aluminum Relieved Set Screw Type

Ordering Number System for Single Beam Models Example: 826.25.2030

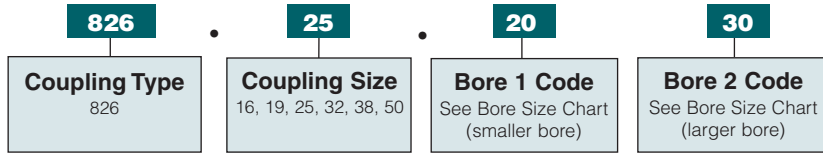

Order as one complete coupling part number with two bores. Include (.) in Part Number.

See page 5 for **keywayed** bores and more detailed ordering information.

Specifications										Part Number Examples		
Coupling Type	Coupling Size	O.D. D in. (mm)	Length L in. (mm)	Hub L1 in. (mm)	Torque* Capacity lb.-in. (Nm)	Misalignment Capacity**		Weight Lb (kg)	Bore		Part Number	
						Angular Degree	Radial in. (mm)		B1	B2		
826	16	.63 (15.9)	.79 (20.0)	.24 (6.0)	5.3 (6)	5	.010 (.25)	.019 (.0088)	4mm	4mm	826.16.1818	
									3/16	3/16	826.16.1919	
									5mm	5mm	826.16.2020	
									6mm	6mm	826.16.2222	
									1/4	1/4	826.16.2424	
826	19	.75 (19.1)	.79 (20.0)	.24 (6.0)	9.7 (1.1)	5	.010 (.25)	.029 (.013)	5mm	6mm	826.19.2022	
									6mm	6mm	826.19.2222	
									6mm	8mm	826.19.2228	
									1/4	1/4	826.19.2424	
826	25	1.00 (25.4)	.94 (24.0)	.30 (7.5)	19.5 (2.2)	5	.010 (.25)	.062 (.028)	8mm	8mm	826.25.2828	
									8mm	10mm	826.25.2832	
									1/4	3/8	826.25.2431	
									3/8	3/8	826.25.3131	
									10mm	10mm	826.25.3232	
826	32	1.25 (31.8)	1.18 (30.0)	.39 (10.0)	36.3 (4.1)	5	.010 (.25)	.121 (.055)	10mm	10mm	826.32.3232	
									12mm	12mm	826.32.3535	
									13mm	13mm	826.32.3737	
									1/4	1/2	826.32.2436	
									3/8	1/2	826.32.3136	
									1/2	1/2	826.32.3636	
									5/8	5/8	826.32.4141	
826	38	1.50 (38.1)	1.97 (50.0)	.63 (16.0)	88.5 (10.0)	5	.010 (.25)	.280 (.127)	3/8	3/8	826.38.3131	
									1/2	1/2	826.38.3636	
									1/2	5/8	826.38.3641	
									14mm	14mm	826.38.3838	
									5/8	5/8	826.38.4141	
									16mm	16mm	826.38.4242	
826	50	2.00 (50.8)	2.13 (54.0)	.71 (18.0)	132.8 (15.0)	5	.010 (.25)	.531 (.241)	19mm	19mm	826.50.4646	
									3/4	3/4	826.50.4747	
									3/4	1	826.50.4753	
									22mm	22mm	826.50.4949	
									7/8	7/8	826.50.5050	
									24mm	24mm	826.50.5151	
									25mm	25mm	826.50.5252	
									1	1	826.50.5353	

*Torque Capacity is the maximum continuous rated torque assuming no misalignment. See page 52 for Torque Capacity Service Factors.

**Maximum misalignment values are mutually exclusive.

Single-Beam | Beam Couplings

Aluminum Relieved Clamp Collar Type



Typical Applications

- Stepper drives
- Encoders
- General purpose light-duty power transmission

General Specifications

- Temperature range: -40 to +120 Degrees C.
- Standard speed rating: 5,000 rpm maximum.
- Standard fasteners are 100% metric.

Materials & Finishes

- **Couplings:** Aluminum L 168 or better
- **Fasteners:** Alloy steel, black oiled

Options

- **Keyways can be provided.** Consult Technical Support.

Dimensions

Clamp Hubs

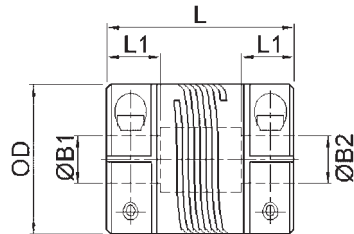

Coupling Type
827

• = B1 only • = B1 & B2

Sizes indicated in parenthesis are metric (mm).

Standard Bore Sizes (0.03 – 0.00mm)																						
Bore Code	14	16	18	19	20	22	24	27	28	30	31	32	35	36	38	40	41	42	47	48	52	53
Bore Size	(3)	1/8"	(4)	3/16"	(5)	(6)	1/4"	5/16"	(8)	(9)	3/8"	(10)	(12)	1/2"	(14)	(15)	5/8"	(16)	3/4"	(20)	(24)	(25)
Coupling Size																						
16	•	•	•	•	•	•	•															
19			•	•	•	•	•		•													
25					•	•	•	•	•	•	•	•										
32						•	•	•	•	•	•	•	•	•	•	•	•					
38											•	•	•	•	•	•	•	•				
50														•	•	•	•	•	•	•	•	•

For a complete list of bore sizes see page 5.

Visit www.bostongear.com to identify which parts are stocked items.
If your bore combination is not stocked select a coupling to match your larger shaft size and select a bore reducer from page 56 to fit your smaller shaft.

Beam Couplings | Single-Beam

Aluminum Relieved Clamp Collar Type

Ordering Number System for Single Beam Models Example: 827.25.2430

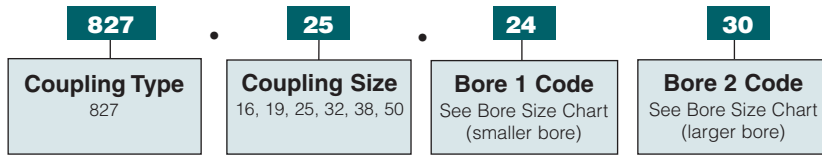

Order as one complete coupling part number with two bores. Include (.) in Part Number.

See page 5 for **keywayed** bores and more detailed ordering information.

Specifications									Part Number Examples		
Coupling Type	Coupling Size	O.D. D in. (mm)	Length L in. (mm)	Hub L1 in. (mm)	Torque* Capacity lb.-in. (Nm)	Misalignment Capacity**		Weight Lb (kg)	Bore		Part Number
						Angular Degree	Radial in. (mm)		B1	B2	
827	16	.63 (15.9)	.87 (22.0)	2.6 (6.5)	5.3 (.6)	5	.010 (.25)	.019 (.0088)	4mm	4mm	827.16.1818
									3/16	3/16	827.16.1919
									5mm	5mm	827.16.2020
									6mm	6mm	827.16.2222
									1/4	1/4	827.16.2424
827	19	.75 (19.1)	1.10 (28.0)	.32 (8.0)	9.7 (1.1)	5	.010 (.25)	.029 (.013)	5mm	6mm	827.19.2022
									6mm	6mm	827.19.2222
									6mm	8mm	827.19.2228
									1/4	1/4	827.19.2424
									827	25	1.00 (25.4)
8mm	10mm	827.25.2832									
1/4	3/8	827.25.2431									
3/8	3/8	827.25.3131									
10mm	10mm	827.25.3232									
827	32	1.25 (31.8)	1.5 (38.0)	.47 (12.0)	36.3 (4.1)	5	.010 (.25)	.121 (.055)	10mm	10mm	827.32.3232
									12mm	12mm	827.32.3535
									13mm	13mm	827.32.3737
									1/4	1/2	827.32.2436
									3/8	1/2	827.32.3136
									1/2	1/2	827.32.3636
									5/8	5/8	827.32.4141
827	38	1.50 (38.1)	1.97 (50.0)	.63 (16.0)	88.5 (10.0)	5	.010 (.25)	.280 (.127)	3/8	3/8	827.38.3131
									1/2	1/2	827.38.3636
									1/2	5/8	827.38.3641
									14mm	14mm	827.38.3838
									5/8	5/8	827.38.4141
									16mm	16mm	827.38.4242
827	50	2.00 (50.8)	2.13 (54.0)	.71 (18.0)	132.8 (15.0)	5	.010 (.25)	.531 (.241)	19mm	19mm	827.50.4646
									3/4	3/4	827.50.4747
									3/4	1	827.50.4753
									22mm	22mm	827.50.4949
									7/8	7/8	827.50.5050
									24mm	24mm	827.50.5151
									25mm	25mm	827.50.5252
									1	1	827.50.5353

*Torque Capacity is the maximum continuous rated torque assuming no misalignment. See page 52 for Torque Capacity Service Factors.

**Maximum misalignment values are mutually exclusive.

Step-Beam | Beam Couplings

Nylon Set Screw & Clamp Types



Typical Applications

- Encoders
- Tachogenerators
- Small pumps, motors and drives
- Applications requiring high electrical insulation

General Specifications

- Temperature range: -20 to +150 Degrees C.
- Standard speed rating: 10,000 rpm maximum.
- Standard fasteners are 100% metric.

Materials & Finishes

- **Couplings:** Nylon type engineering polymer
- **Fasteners:** Stainless Steel

Dimensions

Set Screw Hubs

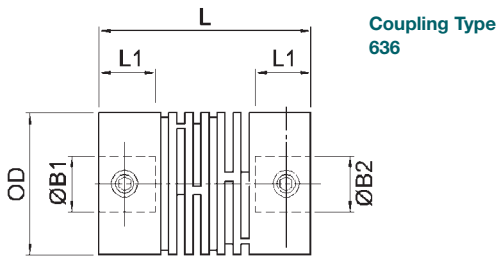

Clamp Hubs

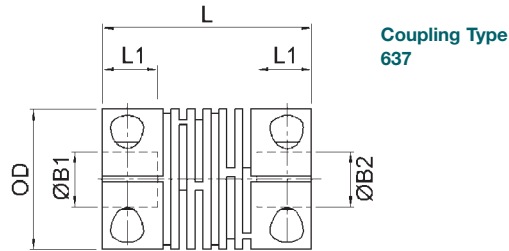

Sizes indicated in parenthesis are metric (mm).

Standard Bore Sizes (0.05 – 0.00mm)

Bore Code	14	16	18	19	20	22	24	27	28	31	32	35	36
Bore Size	(3)	1/8"	(4)	3/16"	(5)	(6)	1/4"	5/16"	(8)	3/8"	(10)	(12)	1/2"
Coupling Size													
13	•	•	•	•	•	•	•						
19			•	•	•	•	•	•	•	•			
25						•		•	•	•	•	•	•

For a complete list of bore sizes see page 5.

Visit www.bostongear.com to identify which parts are stocked items.
If your bore combination is not stocked select a coupling to match your larger shaft size and select a bore reducer from page 56 to fit your smaller shaft.

Beam Couplings | Step-Beam

Nylon Set Screw & Clamp Types

Ordering Number System for Single Beam Models Example: 637.19.2028

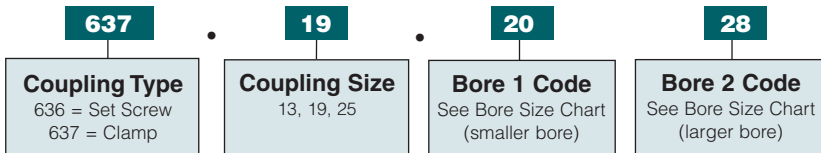

Order as one complete coupling part number with two bores. Include (.) in Part Number.

Specifications										Part Number Examples			
Coupling Type	Coupling Size	O.D. D in. (mm)	Length L in. (mm)	Hub L1 in. (mm)	Torque* Capacity lb.-in. (Nm)	Misalignment Capacity**		Weight Lb (kg)	Bore		Set-Screw Style Part Number	Clamp Style Part Number	
						Angular Degree	Radial in. (mm)		B1	B2			
636 Set Screw or 637 Clamp Style	13	.51 (13.0)	.71 (18.0)	.20 (5.0)	2.2 (.25)	3	.006 (.15)	.0066 (.003)	4mm	4mm	636.13.1818	637.13.1818	
									3/16	3/16	636.13.1919	637.13.1919	
									5mm	5mm	636.13.2020	637.13.2020	
									6mm	6mm	636.13.2222	637.13.2222	
									1/4	1/4	636.13.2424	637.13.2424	
	19	.75 (19.0)	1.10 (28.0)	.31 (8.0)	7.0 (.80)	4	.006 (.15)	.0165 (.0075)	6mm	6mm	636.19.2222	637.19.2222	
									1/4	1/4	636.19.2424	637.19.2424	
									8mm	8mm	636.19.2828	637.19.2828	
									3/8	3/8	636.19.3131	637.19.3131	
									8mm	8mm	636.25.2828	637.25.2828	
25	0.98 (25.0)	1.42 (36.0)	.39 (10.0)	22.0 (2.50)	5	.012 (.30)	.038 (.0174)	3/8	3/8	636.25.3131	637.25.3131		
								10mm	10mm	636.25.3232	637.25.3232		
								12mm	12mm	636.25.3535	637.25.3535		
								1/2	1/2	636.25.3636	637.25.3636		
								1/2	1/2	636.25.3636	637.25.3636		

*Torque Capacity is the maximum continuous rated torque assuming no misalignment. See page 52 for Torque Capacity Service Factors.

**Maximum misalignment values are mutually exclusive.

Oldham | General Purpose Couplings

Blind Set Screw and Clamp Types



Typical Applications

- Stepper drives
- Positioning slides
- Pumps
- Actuators

General Specifications

- Temperature range: -20 to +60 Degrees C.
- Standard speed rating: 3,000 rpm maximum.
- Standard fasteners are 100% metric.

Materials & Finishes

- **Hubs:** Size 9-13 brass, size 19-41 aluminum
- **Fasteners:** Alloy steel, black oiled
- **Discs:** Types 236 – Acetal (black), Size 33 = 836
Types 238 – Nylon 11 (natural), Size 33 = 838

Options

- Through bored disc/inserts are available. Add suffix T to end of part number.

Dimensions

Blind Hubs

(shaft will not pass through coupling)

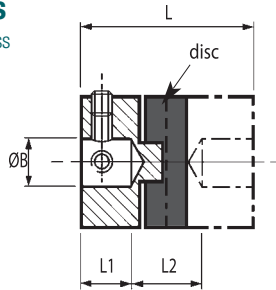

Coupling Type 232
Set Screw style

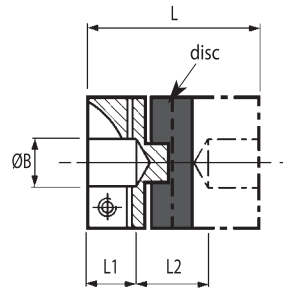

Coupling Type 234 & 235
Clamp style

Sizes indicated in parenthesis are metric (mm).

Standard Bore Sizes (0.03 – 0.00mm)

Bore Code	14	16	18	19	20	22	24	28	31	32	35	36	38	40	41	42	45	46	47	48
Bore Size	(3)	1/8"	(4)	3/16"	(5)	(6)	1/4"	(8)	3/8"	(10)	(12)	1/2"	(14)	(15)	5/8"	(16)	(18)	(19)	3/4"	(20)
Coupling Size																				
09	•	•	•	•	•															
13	•	•	•	•	•	•	•													
19		•	•	•	•	•	•													
25					•	•	•	•	•	•										
33								•	•	•	•	•	•	•	•	•				
41									•	•	•	•	•	•	•	•	•	•	•	•

For a complete list of bore sizes see page 5.

Visit www.bostongear.com to identify which parts are stocked items.

General Purpose Couplings | Oldham

Blind Set Screw and Clamp Type

Ordering Number System for Oldham Models

Example: 232.19.20

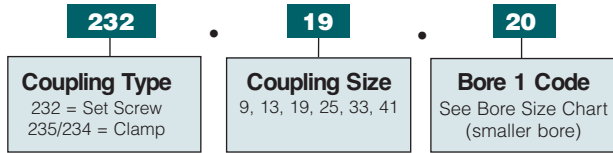

Two hubs and one disc/insert required per coupling. Include (.) in Part Number.

Specifications											Part Number Examples				
Coupling Type	Coupling Size	O.D. D in. (mm)	Length L in. (mm)	Hub L1 in. (mm)	Inertia WK ² (KGM ² x 10 ⁻⁴)	Torque* Capacity lb.-in. (Nm)	Misalignment Capacity** @ 3000 RPM			Torsional Stiffness (Nm/rad)	Weight Lb (kg)	B Bore	Set Screw Hub Part Number	Clamp Hub Part Number	Disc/Insert Part Number
							Angular Degree	Radial in. (mm)	Axial in. (±mm)						
232	09	.38 (9.5)	.50 (12.7)	.15 (3.8)	(18)	1.8 (0.21)	0.5	.004 (0.1)	.002 (0.05)	(10)	0.01 (.004)	3mm	232.09.14	-	236.09H
												4mm	232.09.18	-	
												3/16	232.09.19	-	
232	13	.50 (12.7)	.63 (15.9)	.17 (4.3)	(26)	4.4 (.50)	0.5	.004 (0.1)	.002 (0.05)	(30)	0.024 (.011)	5mm	232.13.20	-	236.13H
												6mm	232.13.22	-	
												1/4	232.13.24	-	
232 or 235	19	.75 (19.1)	.87 (22.0)	.25 (6.3)	(67)	15.0 (1.7)	0.5	.008 (0.2)	.004 (0.1)	(115)	0.026 (.012)	4mm	232.19.18	235.19.18	236.19H
												3/16	232.19.19	235.19.19	
												5mm	232.19.20	235.19.20	
												6mm	232.19.22	235.19.22	
												1/4	232.19.24	235.19.24	
												7mm	232.19.25	235.19.25	
232 or 234	25	1.00 (25.4)	1.12 (28.4)	.34 (8.6)	(252)	35.0 (4.0)	0.5	.008 (0.2)	.004 (0.1)	(205)	0.068 (.031)	5/16	232.25.27	234.25.27	236.25H
												8mm	232.25.28	234.25.28	
												9mm	232.25.30	234.25.30	
												3/8	232.25.31	234.25.31	
												10mm	232.25.32	234.25.32	
												11mm	232.25.33	234.25.33	
												12mm	232.25.35	234.25.35	
												8mm	232.33.28	234.33.28	
232 or 234	33	1.31 (33.3)	1.65 (42.0)	.51 (13.0)	(1074)	80.0 (9.0)	0.5	.008 (0.2)	.006 (0.15)	(615)	0.16 (.072)	3/8	232.33.31	234.33.31	836.33H
												10mm	232.33.32	234.33.32	
												11mm	232.33.33	234.33.33	
												12mm	232.33.35	234.33.35	
												13mm	232.33.37	234.33.37	
												1/2	232.33.36	234.33.36	
												5/8	232.33.41	234.33.41	
232 or 234	41	1.63 (41.3)	2.00 (50.8)	.66 (16.7)	(3327)	150.0 (17.0)	0.5	.010 (0.25)	.006 (0.15)	(1200)	0.33 (.148)	3/8	232.41.31	234.41.31	236.41H
												10mm	232.41.32	234.41.32	
												11mm	232.41.33	234.41.33	
												12mm	232.41.35	234.41.35	
												1/2	232.41.36	234.41.36	
												14mm	232.41.38	234.41.38	
												15mm	232.41.40	234.41.40	
												5/8	232.41.41	234.41.41	
												16mm	232.41.42	234.41.42	
3/4	232.41.47	234.41.47													

*Torque Capacity is the maximum continuous rated torque assuming no misalignment. See page 52 for Torque Capacity Service Factors.

**Maximum misalignment values are mutually exclusive.

Oldham | General Purpose Couplings

Through Bored Set Screw and Clamp Types



Typical Applications

- Stepper drives
- Positioning slides
- Pumps
- Actuators

General Specifications

- Temperature range: -20 to +60 Degrees C.
- Standard speed rating: 3,000 rpm maximum.
- Standard fasteners are 100% metric.

Materials & Finishes

- **Hubs:** Aluminum
- **Fasteners:** Alloy steel, black oiled
- **Discs:** Types 236 – Acetal (black), Size 33 = 836
Types 238 – Nylon 11 (natural), Size 33 = 838

Options

- Through bored disc/inserts are available. Replace “H” with suffix “T” to end of part number. Example 238.33T.
- Stainless versions available

Dimensions

Through Bore Hubs

(shaft will pass completely through coupling)

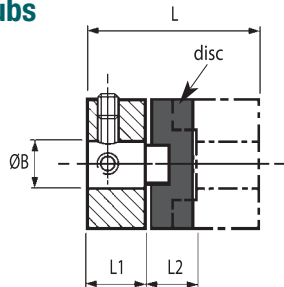

Coupling Type 450
Set Screw style

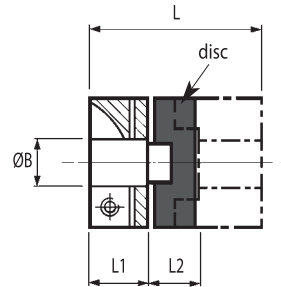

Coupling Type 452 or 453
Clamp style

Sizes indicated in parenthesis are metric (mm).

Standard Bore Sizes (0.03 – 0.00mm)

Bore Code	18	19	20	22	24	28	31	32	35	36	38	40	41	42	45	46	47	48	51	52
Bore Size	(4)	3/16"	(5)	(6)	1/4"	(8)	3/8"	(10)	(12)	1/2"	(14)	(15)	5/8"	(16)	(18)	(19)	3/4"	(20)	(24)	(25)
Coupling Size																				
19	•	•	•	•	•	•														
25				•	•	•	•	•	•											
33						•	•	•	•	•	•	•	•	•						
41							•	•	•	•	•	•	•	•	•	•	•	•		
50							•	•	•	•	•	•	•	•	•	•	•	•	•	•

For a complete list of bore sizes see page 5.

Visit www.bostongear.com to identify which parts are stocked items.

General Purpose Couplings | Oldham

Through Bored Set Screw and Clamp Types

Ordering Number System for Oldham Models

Example: 450H33.36

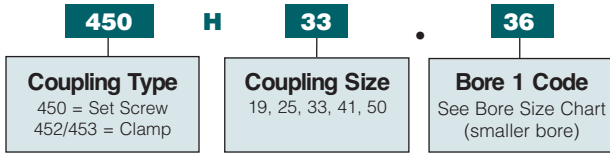

Two hubs and one disc/insert required per coupling. Include (.) in Part Number.

See page 5 for **keywayed** bores and more detailed ordering information.

Specifications											Part Number Examples				
Coupling Type	Coupling Size	O.D. D in. (mm)	Length L in. (mm)	Hub L1 in. (mm)	Inertia WK ² (KGM ² x 10 ⁻⁴)	Torque* Capacity lb.-in. (Nm)	Misalignment Capacity** @ 3000 RPM			Torsional Stiffness (Nm/rad)	Weight Lb (kg)	B Bore	Set Screw Hub Part Number	Clamp Hub Part Number	Disc/Insert Part Number
							Angular Degree	Radial in. (mm)	Axial in. (±mm)						
450H19 or 453H19	19	.75 (19.1)	1.02 (26.0)	.37 (9.4)	(59.0)	15.0 (1.7)	0.5	.008 (0.2)	.004 (0.1)	(115)	0.026 (.012)	4mm	450H19.18	453H19.18	236.19H
												3/16	450H19.19	453H19.19	
												5mm	450H19.20	453H19.20	
												6mm	450H19.22	453H19.22	
												1/4	450H19.24	453H19.24	
												7mm	450H19.25	453H19.25	
												5/16	450H19.27	453H19.27	
450H25 or 452H25	25	1.00 (25.4)	1.28 (32.4)	.46 (11.6)	(252)	35.0 (4.0)	0.5	.008 (0.2)	.004 (0.1)	(205)	0.068 (.031)	6mm	450H25.22	452H25.22	236.25H
												1/4	450H25.24	452H25.24	
												5/16	450H25.27	452H25.27	
												8mm	450H25.28	452H25.28	
												9mm	450H25.30	452H25.30	
												3/8	450H25.31	452H25.31	
												10mm	450H25.32	452H25.32	
												11mm	450H25.33	452H25.33	
												11mm	450H25.33	452H25.33	
												12mm	450H25.35	452H25.35	
450H33 or 452H33	33	1.31 (33.3)	1.65 (42.0)	.59 (15.0)	(1080)	80.0 (9.0)	0.5	.008 (0.2)	.006 (0.15)	(615)	0.19 (.086)	8mm	450H33.28	452H33.28	836.33H
												3/8	450H33.31	452H33.31	
												10mm	450H33.32	452H33.32	
												11mm	450H33.33	452H33.33	
												12mm	450H33.35	452H33.35	
												1/2	450H33.36	452H33.36	
												5/8	450H33.41	452H33.41	
450H41 or 452H41	41	1.63 (41.3)	2.00 (50.8)	.70 (17.8)	(3177)	150.0 (17.0)	0.5	.010 (0.25)	.006 (0.15)	(1200)	0.33 (.148)	3/8	450H41.31	452H41.31	236.41H
												10mm	450H41.32	452H41.32	
												11mm	450H41.33	452H41.33	
												12mm	450H41.35	452H41.35	
												1/2	450H41.36	452H41.36	
												13mm	450H41.37	452H41.37	
												14mm	450H41.38	452H41.38	
												15mm	450H41.40	452H41.40	
												5/8	450H41.41	452H41.41	
												16mm	450H41.42	452H41.42	
450H50 or 452H50	50	1.97 (50)	2.35 (59.6)	.81 (20.6)	(7550)	760.0 (30.0)	0.5	.010 (0.25)	.008 (0.2)	(1375)	0.46 (.208)	3/8	450H50.31	452H50.31	236.50H
												10mm	450H50.32	452H50.32	
												11mm	450H50.33	452H50.33	
												12mm	450H50.35	452H50.35	
												1/2	450H50.36	452H50.36	
												14mm	450H50.38	452H50.38	
												15mm	450H50.40	452H50.40	
												5/8	450H50.41	452H50.41	
												11/16	450H50.44	452H50.44	
												18mm	450H50.45	452H50.45	
												19mm	450H50.46	452H50.46	
												3/4	450H50.47	452H50.47	
												20mm	450H50.48	452H50.48	
												22mm	450H50.49	452H50.49	
												7/8	450H50.50	452H50.50	
												24mm	450H50.51	452H50.51	
												25mm	450H50.52	452H50.52	
1.000*	450H50.53	452H50.53													

*Torque Capacity is the maximum continuous rated torque assuming no misalignment. See page 52 for Torque Capacity Service Factors.

**Maximum misalignment values are mutually exclusive.

Uni-Lat | General Purpose Couplings

Set Screw Type



Typical Applications

- Encoders
- Resolvers
- Tacho
- Potentiometer drives
- Small positioning slides
- Dosing pumps
- General light drives

General Specifications

- Temperature range: -20 to +60 Degrees C.
- Standard speed rating: 3,000 rpm maximum.
- Standard fasteners are 100% metric.

Materials & Finishes

- **Hub sizes 18 & 27:** Brass BS 2874 CZ121
- **Hub sizes 34 & 41:** Al Alloy AIECO 62Sn T9 Irridite NCP
- **Fasteners:** Alloy steel, black oiled
- **Torque rings:** Acetal (black)
(all sizes)

Options

- **Keyways can be provided.** Specify an "R" bore code prefix for inch keyways and "P" for metric (Ex: 203.70.R41R41).

Dimensions

Set Screw Hubs

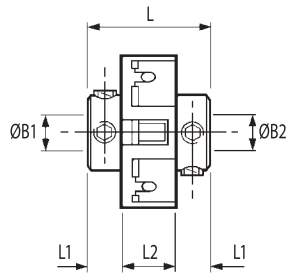

Coupling Type
201 or 203
Small Bores

Sizes indicated in parenthesis are metric (mm).

Standard Bore Sizes (0.03 – 0.00mm)																				
Bore Code	14	16	18	19	20	22	24	27	28	31	32	35	36	38	41	42	45	46	47	50
Bore Size	(3)	1/8"	(4)	3/16"	(5)	(6)	1/4"	5/16"	(8)	3/8"	(10)	(12)	1/2"	(14)	5/8"	(16)	(18)	(19)	3/4"	(20)
Coupling Size																				
18	•	•	•	•	•															
27					•	•	•	•	•											
34						•	•		•	•	•									
41						•	•		•	•	•	•	•							
70												•	•	•	•	•	•	•	•	•

For a complete list of bore sizes see page 5.

Visit www.bostongear.com to identify which parts are stocked items.
If your bore combination is not stocked select a coupling to match your larger shaft size and select a bore reducer from page 56 to fit your smaller shaft.

General Purpose Couplings | Uni-Lat

Set Screw Type

Ordering Number System for Uni-Lat Models

Example: 201.27.2024

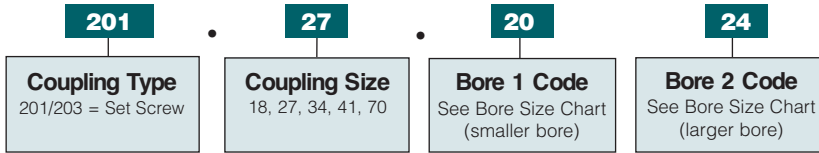

Order as one complete coupling part number with two bores. Include (.) in Part Number.

See page 5 for **keywayed** bores and more detailed ordering information.

Specifications											Part Number Examples		
Coupling Type	Coupling Size	O.D. D in. (mm)	Length L in. (mm)	Hub L1 in. (mm)	Torque* Capacity lb.-in. (Nm)	Misalignment Capacity**				Weight Lb (kg)	Bore		Set Screw Part Number
						Angular @ 3000 RPM Degree	Angular @ 1000 RPM (mm)	Angular @ 500 RPM Degree	Radial in. (mm)		B1	B2	
201	18	.71 (18.0)	.56 (14.2)	.18 (4.6)	2.6 (.3)	2	5	10	.008 (.2)	.015 (.007)	3mm	3mm	201.18.1414
											1/8	1/8	201.18.1616
											4mm	4mm	201.18.1818
											3/16	3/16	201.18.1919
											5mm	5mm	201.18.2020
201	27	1.10 (28.0)	.75 (19.1)	.24 (6.1)	15.0 (1.7)	2	2	10	.008 (.2)	.035 (.016)	5mm	5mm	201.27.2020
											5mm	6mm	201.27.2022
											6mm	6mm	201.27.2222
											6mm	8mm	201.27.2228
											1/4	1/4	201.27.2424
201	34	1.33 (33.7)	.99 (25.2)	.32 (8.1)	22.1 (2.5)	2	2	10	.010 (.25)	.037 (.017)	8mm	8mm	201.27.2828
											1/4	1/4	201.34.2424
											1/4	3/8	201.34.2431
											5/16	5/16	201.34.2727
											3/8	3/8	201.34.3131
201	41	1.63 (41.4)	1.12 (28.4)	.34 (8.6)	31.0 (3.5)	2	2	10	.010 (.25)	.066 (.030)	10mm	10mm	201.34.3232
											6mm	6mm	201.41.2222
											8mm	8mm	201.41.2828
											8mm	10mm	201.41.2832
											3/8	1/2	201.41.3136
203	70	1.14 (69.0)	2.91 (74.0)	1.12 (28.5)	106.2 (12.0)	2	2	10	.010 (.25)	.417 (.189)	10mm	10mm	201.41.3232
											12mm	12mm	201.41.3535
											1/2	1/2	201.41.3636
											1/2	5/8	203.70.3641
											5/8	5/8	203.70.4141
203	70	1.14 (69.0)	2.91 (74.0)	1.12 (28.5)	106.2 (12.0)	2	2	10	.010 (.25)	.417 (.189)	5/8	3/4	203.70.4147
											16mm	16mm	203.70.4242
											3/4	3/4	203.70.4747

*Torque Capacity is the maximum continuous rated torque assuming no misalignment. See page 52 for Torque Capacity Service Factors.

**Maximum misalignment values are mutually exclusive.

Uni-Lat | General Purpose Couplings

Clamp Collar Type



Typical Applications

- Encoders
- Resolvers
- Tacho
- Potentiometer drives
- Small positioning slides
- Dosing pumps
- General light drives

General Specifications

- Temperature range: -20 to +60 Degrees C.
- Standard speed rating: 3,000 rpm maximum.
- Standard fasteners are 100% metric.

Materials & Finishes

- **Hub sizes 18 & 27:** Brass BS 2874 CZ121
- **Hub sizes 34 & 41:** Al Alloy AIECO 62Sn T9 Irridite NCP
- **Fasteners:** Alloy steel, black oiled
- **Clamp rings:** Al Alloy AIECO 62Sn T9 Irridite NCP (sizes 18 & 27)
- **Torque rings:** Acetal (black)

Options

- **Keyways can be provided.** Specify an "R" bore code prefix for inch keyways and "P" for metric (Ex: 205.70.R41R41).

Dimensions

Clamp Hubs

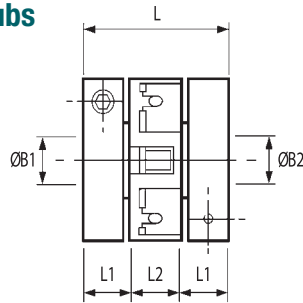

Coupling Type 207
Collet Hub and Ring Clamp

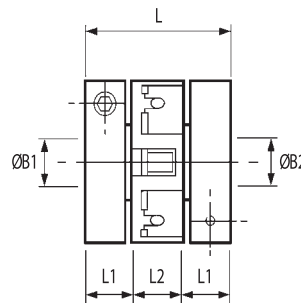

Coupling Type 205 & 206
Integral Leaf Clamp

Sizes indicated in parenthesis are metric (mm).

Standard Bore Sizes (0.03 – 0.00mm)

Bore Code	14	16	18	19	20	22	24	27	28	31	32	35	36	38	41	42	45	46	47	50
Bore Size	(3)	1/8"	(4)	3/16"	(5)	(6)	1/4"	5/16"	(8)	3/8"	(10)	(12)	1/2"	(14)	5/8"	(16)	(18)	(19)	3/4"	(20)
Coupling Size																				
18	•	•	•	•	•	•	•													
27					•	•	•	•	•	•	•									
34							•	•	•	•	•	•	•							
41							•	•	•	•	•	•	•	•	•	•				
70												•	•	•	•	•	•	•	•	•

For a complete list of bore sizes see page 5.

Visit www.bostongear.com to identify which parts are stocked items. If your bore combination is not stocked select a coupling to match your larger shaft size and select a bore reducer from page 56 to fit your smaller shaft.

General Purpose Couplings | Uni-Lat

Clamp Collar Type

Ordering Number System for Uni-Lat Models

Example: 207.27.2024

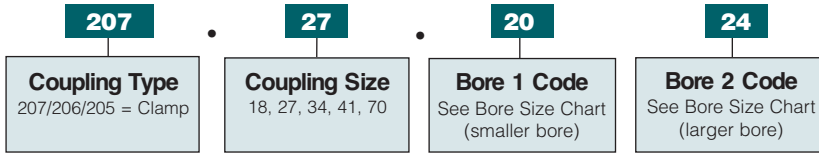

Order as one complete coupling part number with two bores. Include (.) in Part Number.

See page 5 for **keywayed** bores and more detailed ordering information.

Specifications											Part Number Examples		
Coupling Type	Coupling Size	O.D. D in. (mm)	Length L in. (mm)	Hub L1 in. (mm)	Torque* Capacity lb.-in. (Nm)	Misalignment Capacity**				Weight Lb (kg)	Bore		Clamp Collar Part Number
						Angular @ 3000 RPM Degree	Angular @ 1000 RPM (mm)	Angular @ 500 RPM Degree	Radial in. (mm)		B1	B2	
207	18	.71 (18.0)	.75 (19.1)	.28 (7.0)	2.6 (.3)	2	5	10	.008 (.2)	.024 (.011)	3mm	3mm	207.18.1414
											1/8	1/8	207.18.1616
											4mm	4mm	207.18.1818
											3/16	3/16	207.18.1919
											5mm	5mm	207.18.2020
207	27	1.10 (28.0)	1.00 (25.4)	.37 (9.3)	15.0 (1.7)	2	5	10	.008 (.2)	.057 (.026)	5mm	5mm	207.27.2020
											5mm	6mm	207.27.2022
											6mm	6mm	207.27.2222
											6mm	8mm	207.27.2228
											1/4	1/4	207.27.2424
											8mm	8mm	207.27.2828
206	34	1.33 (33.7)	1.21 (30.7)	.43 (10.9)	22.1 (2.5)	2	5	10	.010 (.25)	.044 (.020)	1/4	1/4	206.34.2424
											1/4	3/8	206.34.2431
											5/16	5/16	206.34.2727
											3/8	3/8	206.34.3131
											10mm	10mm	206.34.3232
205	41	1.63 (41.4)	1.50 (38.1)	.53 (13.5)	31.0 (3.5)	2	5	10	.010 (.25)	.088 (.040)	6mm	6mm	205.41.2222
											8mm	8mm	205.41.2828
											8mm	10mm	205.41.2832
											3/8	1/2	205.41.3136
											10mm	10mm	205.41.3232
											12mm	12mm	205.41.3535
											1/2	1/2	205.41.3636
205	70	1.14 (69.0)	2.91 (74.0)	1.12 (28.5)	106.2 (12.0)	2	5	10	.010 (.25)	.417 (.189)	1/2	5/8	205.70.3641
											5/8	5/8	205.70.4141
											5/8	3/4	205.70.4147
											16mm	16mm	205.70.4242
										3/4	3/4	205.70.4747	

*Torque Capacity is the maximum continuous rated torque assuming no misalignment. See page 52 for Torque Capacity Service Factors.

**Maximum misalignment values are mutually exclusive.

Flex-P General Purpose Couplings

Set Screw Type



Typical Applications

- Light power drives
- Pumps
- Small generators

General Specifications

- Temperature range: -40 to +100 Degrees C.
- Standard speed rating: 3,000 rpm maximum.
- Standard fasteners are 100% metric.

Materials & Finishes

- **Hubs:** Steel 230M07 pb Zn plated + clear passivated
- **Flexing Element:** Hytrel
- **Fastener:** Black oxide alloy steel
- **Temperature Range:** -40° C to +100° C
- **Maximum RPM:** 3000 RPM

Options

- **Stainless steel hubs.** Consult Technical Support.

Dimensions

Set Screw Hubs

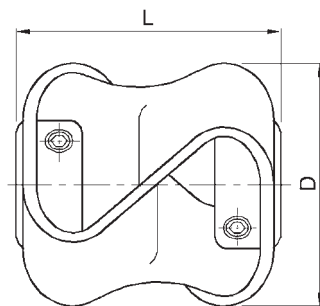

Coupling Type
047

Sizes indicated in parenthesis are metric (mm).

Standard Bore Sizes (0.03 – 0.00mm)																	
Bore Code	14	16	18	19	20	22	24	27	28	31	32	35	36	38	40	41	42
Bore Size	(3)	1/8"	(4)	3/16"	(5)	(6)	1/4"	5/16"	(8)	3/8"	(10)	(12)	1/2"	(14)	(15)	5/8"	(16)
Coupling Size																	
10	•	•	•	•	•	•	•	•	•	•							
20						•	•	•	•	•	•	•	•				
30										•	•	•	•	•	•	•	•
40										•	•	•	•	•	•	•	•

For a complete list of bore sizes see page 5.

Visit www.bostongear.com to identify which parts are stocked items. If your bore combination is not stocked select a coupling to match your larger shaft size and select a bore reducer from page 56 to fit your smaller shaft.

General Purpose Couplings | Flex-P

Set Screw Type

Ordering Number System for Flex P Models Example: 047.30.3238

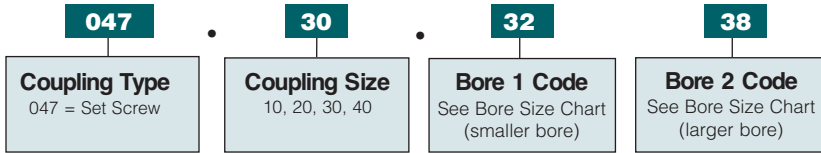

Order as one complete coupling part number with two bores. Include (.) in Part Number.

See page 5 for **keywayed** bores and more detailed ordering information.

Specifications										Part Number Examples	
Coupling Type	Coupling Size	O.D. D in. (mm)	Length L in. (mm)	Hub L1 in. (mm)	Torque* Capacity lb.-in. (Nm)	Misalignment Capacity**		Weight Lb (kg)	Bore		Part Number
						Angular Degree	Radial in. (mm)		A	B	
047	10	1.06 (27)	1.06 (27)	.31 (7.9)	4.4 (.5)	10	.102 (.26)	.055 (.025)	6mm	6mm	047.10.2222
									1/4	1/4	047.10.2424
									8mm	8mm	047.10.2828
									3/8	3/8	047.10.3131
047	20	1.89 (48)	1.89 (48)	.50 (12.7)	15.9 (1.8)	15	.126 (3.2)	.203 (.092)	8mm	8mm	047.20.2828
									10mm	10mm	047.20.3232
									11mm	11mm	047.20.3333
047	30	2.13 (54)	2.17 (55)	.63 (16.0)	44.3 (5.0)	15	.126 (3.2)	.273 (.124)	12mm	12mm	047.30.3535
									1/2	1/2	047.30.3636
									5/8	5/8	047.30.4141
									1/2	1/2	047.40.3636
047	40	2.20 (56)	2.20 (56)	.63 (16.0)	88.5 (10.0)	15	.126 (3.2)	.300 (.136)	13mm	13mm	047.40.3737
									14mm	14mm	047.40.3838
									15mm	15mm	047.40.4040
									5/8	5/8	047.40.4141
									16mm	16mm	047.40.4242

*Torque Capacity is the maximum continuous rated torque assuming no misalignment. See page 52 for Torque Capacity Service Factors.

**Maximum misalignment values are mutually exclusive.

Vari-Tork Friction Clutches

Set Screw Type



Typical Applications

- Motors
- Gear Pumps

General Specifications

- Temperature range: -10 to +80 Degrees C.
- Standard speed rating: 1,000 rpm maximum.
- Standard fasteners are 100% metric.

Materials & Finishes

- **Hubs:** Steel, heat treated
- **Housing, adjuster ring, adaptors:** Al. Alloy AEICO 62Sn T9 Iridite NCP finish
- **Clutch plates:** Size 25 steel, heat treated
- **Bearings:** Sintered
- **Fasteners:** Alloy steel, black oiled

Options

- Available with the clamp or blind style of oldham couplings. Consult Technical Support.

Dimensions

Set Screw Hubs

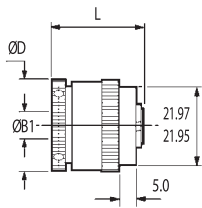

Hub Mounting Type
279

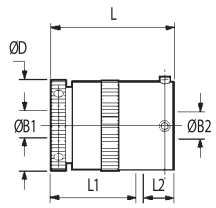

Rigid Coupling Type
281

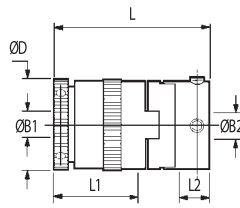

Oldham Coupling Type
285

• = Coupling only bores

Sizes indicated in parenthesis are metric (mm).

Standard Bore Sizes (0.03 – 0.00mm)																
Bore Code	22	22	24	27	28	31	32	35	36	38	41	42	45	46	47	48
Bore Size	(4)	(6)	1/4"	5/16"	(8)	3/8"	(10)	(12)	1/2"	(14)	5/8"	(16)	(18)	(19)	3/4"	(20)
Coupling Size	•	•	•	•	•	•	•	•	•	•	•	•	•	•	•	•

For a complete list of bore sizes see page 5.

Visit www.bostongear.com to identify which parts are stocked items. If your bore combination is not stocked select a coupling to match your larger shaft size and select a bore reducer from page 56 to fit your smaller shaft.

Friction Clutches | Vari-Tork

Set Screw Type

Ordering Number System for Vari-Tork Models Example: 281.25.2436

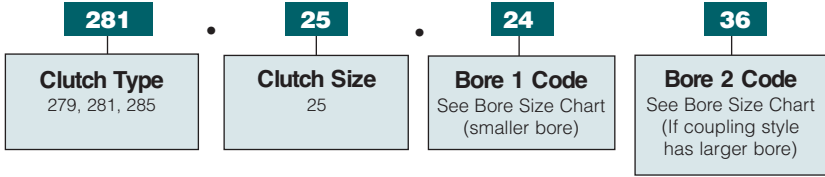

Order as one complete clutch coupling part number with two bores or just one bore in the Hub Mounting Style. Include (.) in Part Number.

Specifications									Part Number Examples		
Coupling Type	Coupling Size	O.D. D in. (mm)	Length L in. (mm)	Hub L1 in. (mm)	Fastener Torque lb.-in. (Nm)	Inertia KGM ² x10 ²	Max. Drag Torque lb.-in. (Ncm)	Weight Lb (kg)	Bore		Part Number
									B1	B2	
279 Hub Mounting	25	1.02 (25.8)	1.28 (32.4)	—	8.3 (.94)	(312)	11.7 (132)	.106 (.048)	6mm	—	279.25.22
									1/4	—	279.25.24
									5/16	—	279.25.27
									8mm	—	279.25.28
281 Rigid Coupling	25	1.02 (25.8)	1.67 (42.5)	1.22 (31.0)	8.3 (.94)	(451)	11.7 (132)	.13 (.06)	6mm	6mm	281.25.2222
									1/4	1/4	281.25.2424
									5/16	5/16	281.25.2727
									8mm	8mm	281.25.2828
									8mm	9mm	281.25.2830
									8mm	3/8	281.25.2831
									8mm	10mm	281.25.2832
									8mm	11mm	281.25.2833
285* Oldham Flexible Coupling	25	1.02 (25.8)	2.10 (53.4)	1.22 (31.0)	8.3 (.94)	(516)	11.7 (132)	.15 (.07)	6mm	6mm	285.25.2222
									1/4	1/4	285.25.2424
									5/16	5/16	285.25.2727
									8mm	8mm	285.25.2828
									8mm	9mm	285.25.2830
									8mm	3/8	285.25.2831
									8mm	10mm	285.25.2832
									8mm	11mm	285.25.2833
8mm	12mm	285.25.2835									

*Coupling misalignment and torque capacity can be found on page 33 for the Oldham size 25 coupling.

Vari-Tork Friction Clutches Installation

How To Install Vari-Tork

Basic Clutch – Refs. 279

Controlled slip occurs between pulley and shaft.

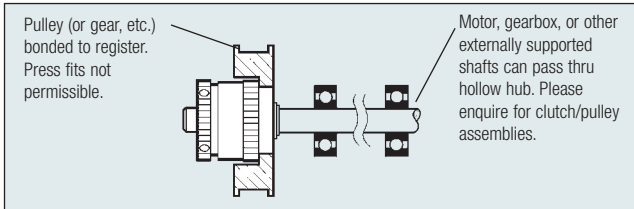

Basic Clutch & Sleeve Adaptor – Refs. 281

Controlled slip occurs between LH & RH shafts. Clutch orientation not important, supported shaft may be entered either end.

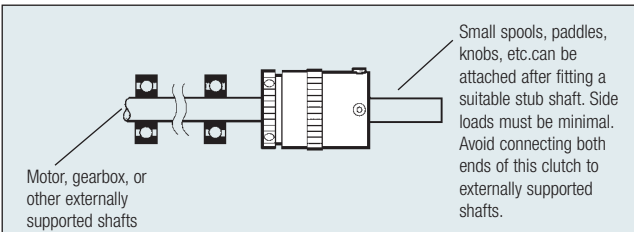

Basic Clutch & Flexible Coupling - Refs. 285

Controlled slip occurs between LH & RH shafts.

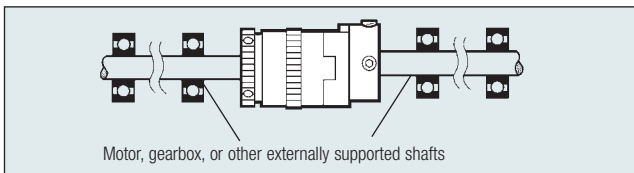

Vari-Tork Characteristics

The characteristics of dry plate clutches favor those applications which can tolerate relatively imprecise drag torques. Three tendencies should be noted:

1. Breakaway Torque

After a period during which no slipping has taken place, the breakaway torque can be up to 2 1/2 times the set value.

2. Torque Decay

There is an inverse relationship between clutch temperature and slipping torque. The slipping torque reduces from the set value as the power being dissipated causes the clutch temperature to rise. When slipping continuously, torque settles at approximately 70% of the value set on a new clutch and at approximately 80% of the value set on a used clutch. This characteristic is not speed dependent.

3. Speed Related Torque Fluctuations

Variations in slipping speed cause a momentary increase in the prevailing output torque. The clutches behave more consistently at high speed/low torque than at low speed/high torque. High speed in this instance starts at approximately 500 rpm.

Where applications call for sustained slipping, the housing temperature should be maintained below 80°C. Clutches mounted concentrically within pulleys, gear wheels, etc. will be more effective at dissipating heat generated during slipping.

Calculating For Power Dissipation

Given the slipping speed in rpm and the drag torque in Nm, the following equation can be used for calculating the power dissipation in watts (W).

$$W = \frac{Nm \cdot rpm}{9.55}$$

Locking Ring

In some circumstances it is possible for the adjuster ring to unscrew during operation. The adjuster ring can be secured by fitting locking ring ref. 294.25.

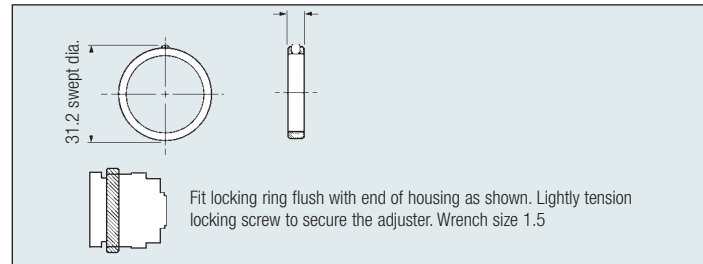

Removing The Adjuster Ring

- 1) If this should be necessary, be sure to replace the pressure plate first, then the spring washers. Ensure that the top most friction ring is fully engaged with the splines. A disengaged friction ring will cause the clutch to malfunction.
- 2) To remove the adjuster ring, first remove the clamp. With set screw hubs the adjuster ring cannot be removed if the set screws protrude above the hub diameter. Flattening or dimpling of shafts is recommended and may be necessary with shafts larger than Ø6.35 to avoid the screws fouling the adjuster ring.

Waved Washers

Two waved washers are fitted to these clutches. In some instances, better torque control may result from removing one of them, particularly when working in the lower torque ranges.

Construction – Size 25 Vari-Tork

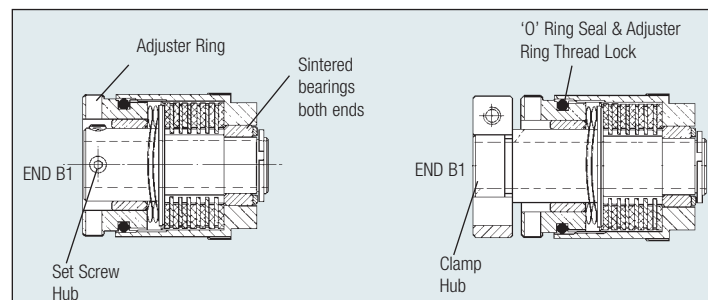

Sectional view of 6-plate Vari-Tork Ref.-279.25
Shafts are secured by set screws accessed through radial holes in the adjuster ring.

Sectional view of 6-plate Vari-Tork Ref.-409.25
Shafts are secured by a split hub and ring clamp method which does not score the shafts.

Coupling Installation Guide

Flexible Coupling Type

General Instructions

1. Ensure that shafts are free of burrs, damage, or foreign matter, and can penetrate the bores.
2. Install the coupling by holding the shaft and the related hub, rotating it back and forth as you progress it along the shaft.
3. Do not apply any forces that cause extension, compression or lateral displacement of the coupling beyond its permissible offsets.

Normal Installation

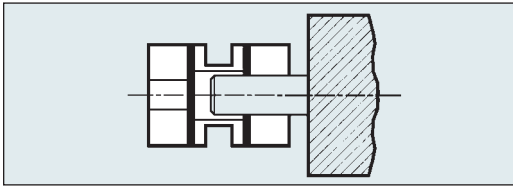

- a) Position and secure the larger of the 2 shafts (if different) and progress the coupling onto it.

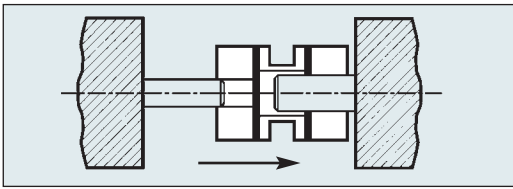

- b) Progress the second shaft into the bore, taking care not to lever either shaft against the inner wall of the spacer.

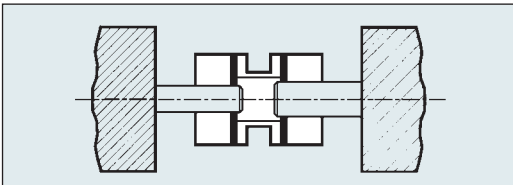

- c) Progress the coupling along the shafts to a position midway between the shaft terminations. Rotate the coupling to ensure it is not binding and is in its natural state, i.e., neither extended nor compressed.
- d) Align the second shaft with the first using a straight edge and feeler gauges or a dial indicator.
- e) Secure the second shaft and re-check alignment. Final alignment must be within the permissible offsets.
- f) Secure one hub, tightening each screw alternately. Repeat for the second hub.

When To Use Single & Two-Stage Couplings

Single-Stage

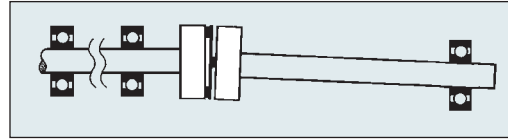

Example 1. With partially supported (1 bearing) shafts.

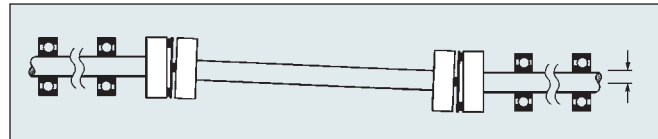

Example 2. With unsupported intermediate shafts.

Single-stage couplings are radially supportive and function as supplementary bearings. They are used when the connected shaft lacks a full complement of bearings.

Two-Stage

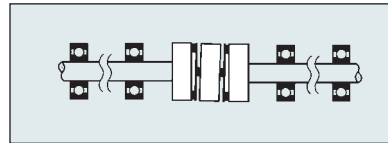

Two-stage couplings are radially compliant and are used when both shafts are fully supported by bearings.

CAUTION

These are precision high couplings that have a limited range of permissible flexure. They can be damaged through careless handling. Avoid gratuitous flexure in any direction. No axial forces are permitted across the membranes when fitting Huco-Flex M couplings. Keyways with interference fits are not recommended. Bellows couplings are more tolerant of axial motion, but flexure beyond the permissible limits should be avoided.

Note: Bellows couplings do not provide the same level of radial support as Flex M when used with partially or wholly unsupported shafts. When essential for reasons of greater axial motion, use the 3-convolution type for these purposes.

Coupling Installation Guide

Sliding Disc Type (Oldham)

Blind Hub

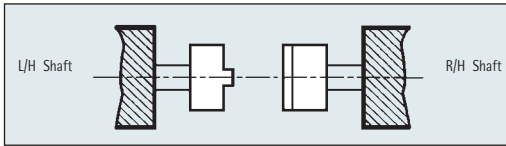

- Slide hubs on to both shafts until fully seated and tighten screws.
- Position and secure R/H shaft.

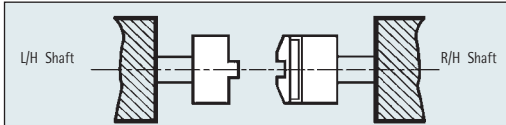

- Seat disc fully on R/H hub.

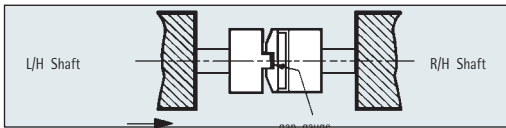

- Place a gap gauge flat against the bottom of the exposed slot in the disc and push the L/H hub into full engagement by manipulating the L/H shaft.
- Align shafts within the permissible offsets and secure L/H shaft.
- Check alignment and correct if necessary.
- Remove gap gauge.
To fit a new disc, withdraw L/H shaft complete with hub and remove old disc. Repeat steps c) to g).

Through Bored Hub

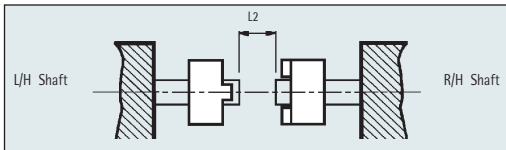

- Slide hubs on to both shafts.
- Align shafts to within the permissible offsets and position to leave minimum gap 2 between terminations. Secure both shafts, check alignment and correct if necessary.

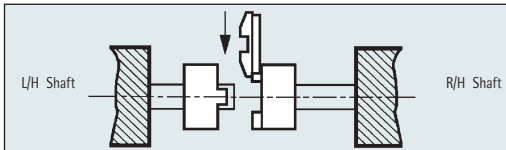

- Position R/H hub with inboard face flush with shaft termination and tighten screws.
- Slide disc radially on to the tenons of the R/H hub. Ensure the disc is fully seated.

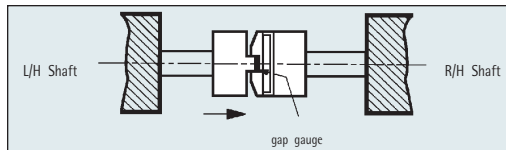

- Place a gap gauge flat against the bottom of the exposed slot in the disc and push the L/H hub into full engagement.

- Tighten fastening screws and remove gap gauge.

To fit a new disc, slacken the fastening screws on one hub and retract it along the shaft. Slide the old disc out radially and replace with the new. Repeat steps d) to f). To retain shaft phasing, withdraw L/H shaft and repeat steps c) to g) as for Blind hub couplings. Over-penetration of shafts can impair function of coupling with solid disc. Min shaft gap L2 must be observed. Specify thro' bored disc for near-butted shafts.

Coupling size	19	25	33	41	50	57
L2 min	7.2	9.2	12.0	15.3	18.4	21.2

Clamp Hubs

To improve clamp action, apply a little grease under the head of the clamp screw.

Gap Gauges for all hub types

Coupling size	06, 09 & 13	Gap gauge	.002" (0.05mm)
	19 & 25		.004" (0.10mm)
	33 & 41		.006" (0.15mm)
	50 & 57		.008" (0.20mm)

Clearances are set to allow for thermal shaft growth and/or end-float. Gaps may be increased, but total shaft movement should not exceed the values shown under **Axial Compensation** in the Performance Table.

Radial Support

Shafts must be fully supported by 2 bearings and have minimal overhang. Oldham couplings cannot be used in pairs.

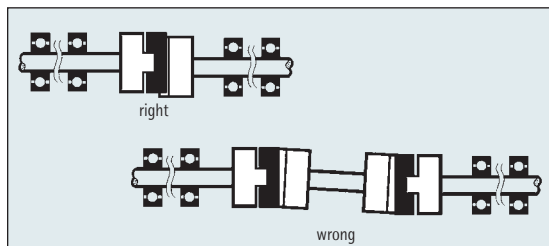

Note: It is important that installed couplings are not end-loaded. To help avoid this, through bored hubs are recommended for shafts which have fixed axial locations such as face-mounted motors.

Coupling Installation Guide

Beam Type

Relief Under The Beams

Most Multi-Beam couplings can be supplied with or without relief under the beams as shown in the diagrams below. When the drive or driven shafts extend under the beams relief is essential to ensure that the coupling remains flexible. Where non-relieved versions are used, shafts must not be allowed to penetrate under the beamed section of the coupling. Unless otherwise specified, relieved versions will be supplied.

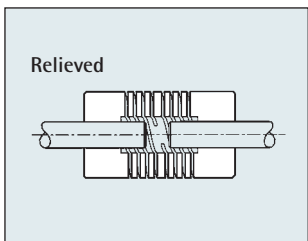
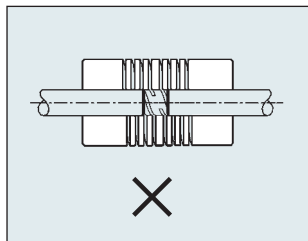
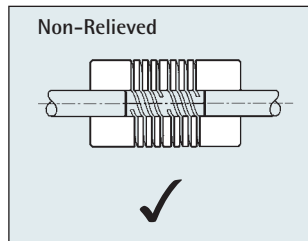

Pilot Bores

Couplings can be supplied 'pilot bored' for opening out by the customer. Pilot bores are plain drilled holes, which are not produced with the same accuracy as finished machined bores. The largest bore provided in a pilot bored product is that needed to make the coupling flexible and this will always be larger than the minimum possible bore size 'B1' shown in the bore tables. For sizes 13 to 25, the pilot bore is also larger than the 'B2' minimum shown in the bore tables. Further details are available on request.

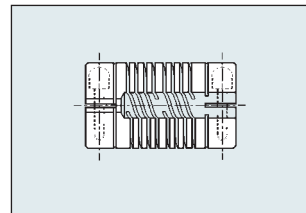

Application Design Guide

Descriptions

Shaft Couplings

In the simplest of terms a coupling's purpose is to transfer rotational movement from one shaft to another. Reality is somewhat more complicated, though, as flexible shaft couplings have also to compensate for misalignment between the two shafts. This ability must be balanced with the need to be pliable in the planes of misalignment while still having the torsional strength to carry out the coupling's main function. This is known as the Compliance Mechanism where compliance is the capacity for allowing relative displacement.

Several factors should always be taken into consideration when looking to specify flexible shaft couplings. These are torsional stiffness, backlash, torque, life and attachment system. All of these have a bearing on coupling selection.

Torsional Stiffness

This is the measure of resistance to torsional rotation in the coupling, and in applications such as closed loop velocity and motion control systems it needs to be high. Whereas in systems where the transmission is subject to shock loads, the coupling typically requires a low torsional stiffness, sometimes referred to as torsional damping.

Backlash

The free play between input and output shafts is commonly referred to as backlash. If rotation is constant then backlash has little impact. However, if the system requires changes in rotational direction, a dwell is created which in high-speed, short cycle applications can create noise and instability. In open-loop systems backlash will also cause loss of accuracy.

Torque

A coupling's torque capacity can be defined in several ways including nominal torque, reversing torque and torque capacity. As far as Huco's products are concerned a coupling's capacity to transfer rotation under load is qualified by its torque capacity rating. This figure is determined through Huco's testing procedures and is the maximum reversing torque applied over at least one million cycles without loss of performance. See page 52 for Service Factors.

Life

The life expectancy of any flexible coupling is dependent on the individual application. Therefore, published performance values, which are based on extensive simulations, are intended as a guide. For instance, where perfect shaft alignment is the case, a coupling can sustain its peak torque value almost indefinitely. However, where misalignment extends beyond the recommended limits, failure can be induced in disc, bellows and helical beam couplings, while wear will be accelerated in universal joints and displacement couplings. Aluminum beam-type couplings will always have a finite fatigue limit when an alternating load is applied.

Attachment Systems

The simplest and most cost-effective method of attaching a coupling to a shaft is to use set screws which locate on flats or dimples on the shaft. Clamps may also be used and have the advantage that as the shaft diameter increases so does traction. For high integrity drive systems a key and keyway system should be employed.



Application Design Guide

Descriptions Cont.

Misalignment

Misalignment, or the variance between the intended position and attitude of two shafts, is normally the result of manufacturing tolerances. Quantifying misalignment is crucial when seeking to specify the correct coupling. As the misalignment increases, the transmissible torque and life expectancy of the coupling reduce exponentially. Therefore, understanding the nature and origins of misalignment is important to you as a design engineer.

The main types of misalignment are angular, radial, and axial displacement.

Factors that influence misalignment include thermal imbalances, wear, settlement and creep, and the influence of the last of these can, without correct maintenance, increase during the life of the coupling.

When determining alignment, measurements should always be taken when the system is cold and again when it is at operating temperature. Consideration should also be given to the class of tolerance being used in the assembly of the individual items. For example, the output shaft of a reduction gearbox with a die-cast housing with unmachined mounting faces and clearance holes for location purposes has a greater possibility for misalignment, than a face-mounted servo motor with machined registers.

Predicting Misalignment

By prediction we really mean verifying the worst-case misalignment in any given situation, so as to be certain that the correction capability of the coupling is adequate. In essence shaft misalignment has three components: parallel, angular, and radial – each being three-dimensional. The following explanation and the accompanying graphics should help in clarifying this situation.

In simple terms a shaft with angular error describes a cone when it is rotated, and while mating shafts can converge and intersect on the critical plane it is unlikely. This gives rise to radial error, which is at its maximum when the axes are tangentially opposed on the sphere diameter.

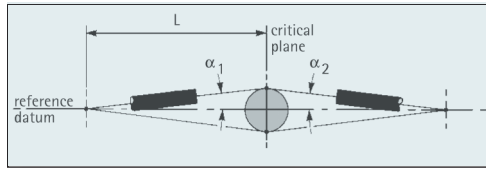

Fig. 1 Worst case angular misalignment = $\alpha_1 + \alpha_2$

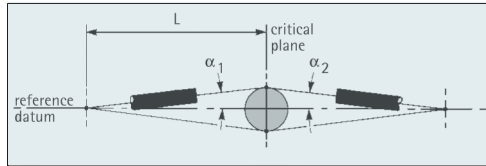

Fig. 2 Maximum radial error = r

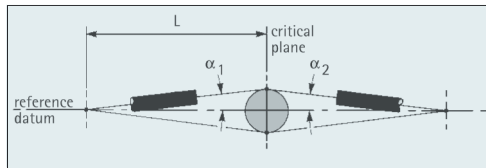

Fig. 3 Maximum parallel error = P_3

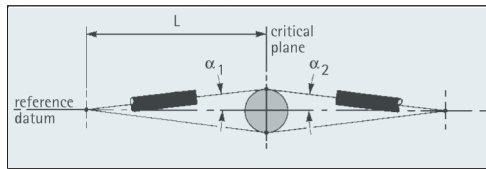

Fig. 4 Worst case radial error $r_2 = P_3 + r$

Application Design Guide

Selecting the Ideal Coupling

Flexible couplings are designed to protect shaft support bearings from destructive radial and thrust loads arising from misalignment and axial motion. In effect, all couplings resist these properties; therefore, the conclusion is that those with least resistance will better protect the bearings. Figure 5 compares the radial bearing loads of some of the most popular couplings based on a nominal outside diameter of 25 mm, with the exception of the jaw coupling where a 30 mm diameter has been used.

Load Torque, Inertia and Torsional Stiffness

In applications where couplings are used to drive frictional loads, for example, pumps, shutter doors and machinery, etc., the coupling's torsional stiffness is not a major factor as the angular synchronization of the shafts is not an issue. However, when resonance is a problem, it is possible to reduce the coupling's torsional stiffness and so avoid conflict with the natural resonance of the machine.

This does not apply when the loads are inertial; typically position and velocity control systems where registration of input and output shafts is critical throughout the operating cycle. In these applications the three elements of motor, coupling and load combine to create a resonant system. The frequency of this system is controlled by the load inertia and the coupling's torsional stiffness. Increasing the inertia, or lowering the torsional stiffness, results in a lower resonant frequency.

In order to control a resonant system you must work well below its resonant frequency. For example, imagine supporting a weight on an elastic band. You can control the weight's vertical movement if you move your hand slowly. Increase the speed and the weight barely moves.

To summarize, when the emphasis is on performance, you require a stiffer coupling in order to reduce settling times, improve positional accuracy and raise the upper limit of dynamic performance.

Selection criteria – which coupling does what?

Flexible Shaft Couplings

Flexible shaft-type couplings compensate for radial and angular misalignment through the flexure of a varying number of compliant elements. This type of coupling includes the multi-stage bellows, helical beam and radial slit concepts.

Points to bear in mind:

- 1) The greater the number of elements, the greater the angular and radial misalignment capacity and the lower the torsional stiffness.
- 2) The forces required to effect compliance are broadly proportional to the torsional stiffness. The stiffer the coupling in torsion, the higher the resulting bearing loads.

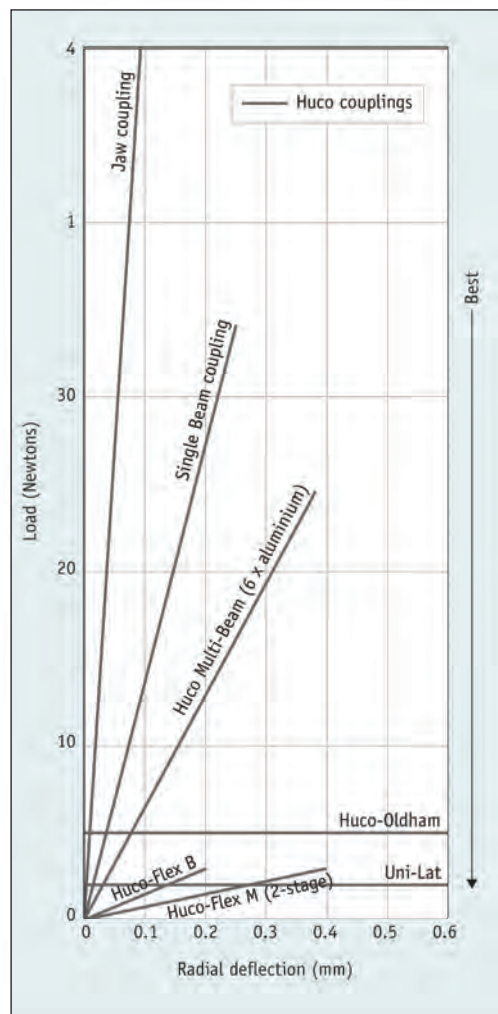

Fig. 5

Application Design Guide



Membrane (Disc) Couplings

Thin pressed spring steel membranes act as the pivotal media in disc couplings. These are attached alternately to the drive and driven members, and provide flex to compensate for misalignment. Any torque is resolved to simple tensile stresses in the opposing segments of the membranes, which are free of residual stresses as no secondary forming operations are involved in their manufacture.

Another advantage of this type of coupling is their near-infinite life and dynamically balanced construction, making them suitable for applications where high rotational speed and high-level motion integrity are required. Typical applications include closed loop servo systems in machine tools, robots, scanners, centrifuges, turbines and dynamometers. When selecting a disc coupling, the user can specify modified spring rates, longer/shorter intermediate members and either keywayed or 'D' bore.



Bellows

The characteristics of the bellows coupling can be modified by varying the number and/or the wall thickness of the convolutions of the bellows. This type of coupling generally has high torsional stiffness and may be used in any drive system where high levels of motion integrity are essential. Typical applications include encoder drives in closed-loop servo systems. Coupling options include modified spring rates, along with keywayed and 'D' bores.



Flexible Beam Couplings

The beam coupling is made from one piece of material achieving its flexibility in all three modes; angular, radial and axial, by means of a slot or slots machined through the wall of the material. Most commonly, the slots are machined helically around the circumference of the coupling. Straight radial slots are also sometimes used.

Helical beam couplings may have one two or three start helices, a three-start helix providing the highest level of torsional stiffness and hence signal accuracy.

Even higher torsional stiffness can be achieved with straight radial beams, however, this is at the expense of radial and angular flexibility.

As with other types of coupling, increased radial compliance is achieved by joining together two flexible coupling 'stages' separated by a spacer.



Plastic Double Loop Couplings

This type of coupling uses a molded plastic element permanently swaged to steel or stainless steel hubs to form an effective two-stage coupling with exceptional flexibility in all three modes. Ideal for transmitting rotation in small drives, this type of coupling works without any friction, wear or noise, although its low torsional stiffness makes it less suitable for high precision positioning applications.

Application Design Guide

The Oldham

This three-part coupling transmits rotation through a central plastic disc that slides over the tenons on the hubs under controlled pre-load to eliminate backlash. The disc can be manufactured from a variety of engineering polymers to suit many different applications. These range from the incremental control of fluid valves to positional systems in machine tools, robots and slide tables. They can also be applied to microstepper and closed loop servo systems and, to a lesser extent, half and full step motor drives. They are available with keywayed or 'D' bores in through bore types, and also with radiation and heat resistant torque discs and free running discs (no pre-load).



The UNI-LAT

To combat angular and radial misalignment this coupling type combines the sliding mechanism of the Oldham with the pivotal action of the universal joint. The process uses a series of integral pins engage a pair of injection molded annular rings that feature controlled pre-load to eliminate backlash. The main features of the UNI-LAT are the generous angular and radial misalignment capacity, along with the fact that they are electrically isolating.

The application area for these couplings is found in general purpose, light-duty stepper (half and full step) encoder, resolver and tachogenerator drives, and light pull-push duties. Optionally supplied with 'D' bores, the UNI-LAT can also have other features machined into the hubs.



Application Design Guide

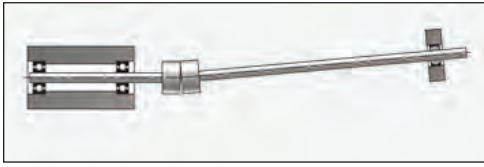

Fig. 6 A semi-floating shaft located by a self-aligning bearing at one end should be supported with a single-stage coupling at the other.

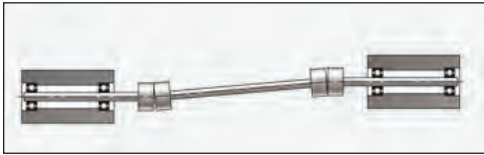

Fig. 7 Two single-stage couplings locate a fully-floating shaft on a stable axis of rotation.

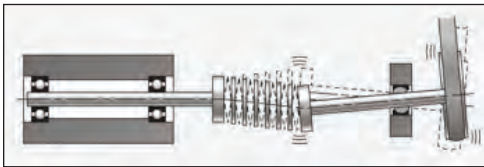

Fig. 8 A semi-floating shaft located by a self-aligning bearing at one end and a multi-stage bellows at the other. The coupling reacts to fluctuating tension in the belt by allowing lateral oscillations in the shaft.

Selecting For True Angular Misalignment

The common causes of true angular misalignment are when one of the connected shafts is compliantly mounted; for example, when it is located by a self-aligning bearing (See figure 6). Alternatively, it could be that an unsupported intermediate shaft is placed between the driver and the load (See figure 7).

Because the shafts are not mounted conventionally, they will self-align to intersect at the center of the coupling, which acts as a hinge and, to a degree, a radial bearing. As the coupling is locating the shafts on a stable axis of rotation, it should be of the single-stage type due to the fact that any radial compliance in the coupling is counter-productive.

While couplings based on the flexible shaft can be used in these circumstances, there is a possibility that the coupled system may go into lateral oscillation. This is best described by visualizing the effect of a belt and pulley drive mounted on the compliant shaft. Having a lateral compliance capacity, the coupling responds to fluctuating tension in the belt by allowing lateral oscillation of the shaft (See figure 8).

The shafts in figure 6 are described as semi-floating, while those in figure 7 are fully-floating. This is an important point as under no circumstances should a coupling with lateral displacement be used with floating shafts. The reason is that this type of coupling has no self-center action and its use would allow the shafts to orbit in an uncontrolled way.

Couplings capable of overcoming true angular misalignment include the **single universal joint** with its capacity to handle large offsets, torsional damping, water resistance and lubrication-free operation. **Single-stage disc couplings** are also ideal, thanks to their near-infinite life and built-in dynamically balanced properties. Similarly, **single-stage bellows** with their high torsional stiffness are a good choice in this application.

Application Design Guide

Selecting For Zero Misalignment

Zero misalignment can be achieved by assembling both shafts in self-aligning bearings (See figure 9). In this way both shafts can float into concentric relationships, allowing the use of a solid coupling which simply supports the shaft in perfect alignment.

Difficulties arise when attempting to connect fixed axis shafts in this way, as the level of alignment is difficult to both achieve and maintain, due to settlement, creep, thermal expansion and contraction. The influence of these factors results in relative movement between the shafts and the alignment achieved in the factory may not be achievable 'in the field'. Therefore, a flexible coupling is always the preferred option.

Before installing a solid coupling an interesting test is to try a flexible coupling first. With the machine at normal operating temperature measure the speed and/or the current drawn by the motor. The difference between these readings and those with the solid coupling indicate the losses generated by the additional friction at the bearings.

Selecting For Torque Capacity

Torque

Torque is the angular force needed to overcome the resistance of a load. Rotating loads have both a frictional and an inertial component, and are classified according to whichever dominates. For example, the resistance encountered by a pump delivering fluid is a frictional load as the inertial part is secondary, assuming that the pump runs continuously at a steady speed. The total application torque comprises the frictional plus inertial elements. If the pump runs at a constant speed, it produces a uniform load and the required power would be given in kW or HP. The kW rating is related to torque by the following formula: torque Nm = kW x 9550 divided by revs per min.

Conversely, a ball-mounted slide table, typified by short cycles of rapid acceleration and deceleration in both directions of rotation, will have inertial loads as the predominant factor. These will determine the reversing torque factor of the coupling.

To be more precise, the maximum torque experienced by the coupling may be dictated by whether braking is applied by the load or the motor. In the following diagrams (fig 10, 11, 12) the arrows indicate the direction of the angular forces due to acceleration, deceleration or braking.

Once the maximum torque in the system is known, the selection of the correct coupling can be made by relating it to the **Torque Capacity**.

Rating. A couplings **Torque Capacity** \geq application torque x service factor. See page 53 for table of service factors.

Note: *The service factor for a non-uniform load is 2. A lower or higher service factor can be incorporated, depending on the service life required. In the case of Huco couplings, the torque capacity rating relates to the static reversing torque load sustained for a minimum of one million cycles under test conditions (zero misalignment).*

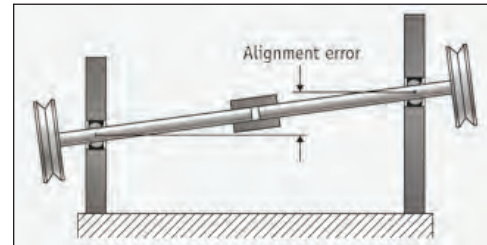

Fig. 9 Shafts located by self-aligning bearings can float into perfect alignment for connection with a solid coupling.

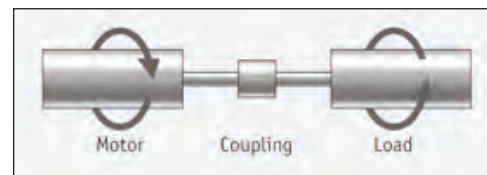

Fig. 10 Mode: Motor accelerates load. Torque 'seen' by coupling = load inertia + frictional resistance of load.

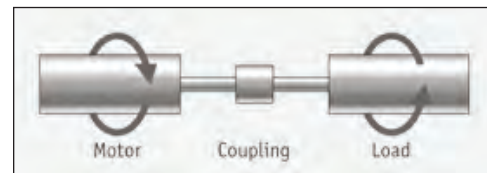

Fig. 11 Mode: Supply to motor discontinued, braking applied to load. Torque 'seen' by coupling = motor inertia - motor drag.

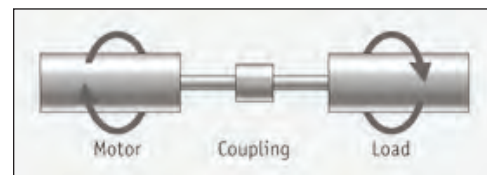

Fig. 12 Mode: Motor decelerates load. Torque 'seen' by coupling (in opposite direction) = load inertia - frictional resistance of load. The coupling 'sees' this as a torque reversal although the direction of rotation is unchanged.

Application Design Guide

Service Factor Chart

A couplings “torque capacity” must be greater than application torque x service factor

	Load					Duty (Hours/Day)				
	Steady State	Stop/Start	Reversing	Shock	Shock & Reversing	<1	1-2	3-5	6-12	>12
Huco Flex B & K	1.5	2.0	2.0	3.0	4.0	-	-	-	-	-
Huco Flex M	1.5	2.0	2.0	3.0	4.0	-	-	-	-	-
Huco Flex P	1.0	1.5	1.5	3.0	4.0	-	-	-	-	-
Huco Multi-Beam	1.0	1.5	2.0	(Note 1)	(Note 1)	-	-	-	-	-
Huco S-Beam	1.0	1.5	2.0	(Note 1)	(Note 1)	-	-	-	-	-
Huco Oldham	-	-	-	-	-	1.0	2.0	4.0	6.0	8.0
Uni-Lat	-	-	-	-	-	1.0	1.5	2.0	3.0	4.0

Note 1: Not recommended in these conditions.

Selecting For Torsional Stiffness

Torsional stiffness may be expressed in several different units, but the most common and easiest to work with is Nm/rad. Often described as torque per unit deflection, torsional stiffness is significant in positional systems and describes a coupling’s resistance to torsional deflection.

Torsional deflection is the inverse of torsional stiffness and is defined by deflection per unit torque. This also has many denominations but is best expressed in degrees/Nm. The conversion tables at the back of this booklet allow conversion from other denominations.

When used in a closed loop or velocity control system a coupling’s torsional stiffness becomes more critical and forms a contributory factor in calculating the upper limit of dynamic performance and stability. Therefore, the stiffness of a coupling should be such that its torsional resonance frequency exceeds 300 – 600 Hz, depending on dynamics. Stiffness is at its most critical when load inertia is dominant and becomes less so when that dominance swings in the motor’s favor. (See figure 13)

$$C_T \geq \frac{(F_R \times 2 \pi)^2}{\left(\frac{1}{J_M} + \frac{1}{J_L}\right)}$$

$$F_R \geq \frac{1}{2 \pi} \times \sqrt{\left(\frac{1}{J_M} + \frac{1}{J_L}\right) \times C_T}$$

Fig. 13 The formulae for torsional stiffness and resonant frequency.

Where

C_T = torsional stiffness
(Nm/rad);

J_M = motor inertia (kgm²);

F_R = resonant frequency (Hz);

J_L = load inertia (kgm²)

Application Design Guide

Selecting for cost, duty and life expectancy

The couplings manufactured by Huco fall into two classifications: mechanical and flexural. The former work through sliding contact, while the latter rely on the flex of the constituent material. The pertinent issues relating to cost, duty and life expectancy are given below.

Oldham or Uni-Lat couplings should be considered when:

1. Cost is the paramount consideration
2. The backlash-free life requirement is within the coupling's backlash-free life expectancy or backlash can be tolerated
3. The coupling is expected to transmit only incremental or periodic rotation
4. The duty is 50% or less, i.e. the coupling is stationary for half of the time or more
5. Radial misalignment is severe and the available space is limited
6. Radial misalignment is difficult to predict or maintain
7. Slight torsional damping is beneficial
8. A three-piece coupling is advantageous. With the Oldham coupling the drive can be connected/disconnected with the hubs in place. The wear element is renewable
9. Electrical isolation of shafts is required
10. The coupling is required to transmit longitudinal motion (push/pull)

Bear in mind that Uni-Lats have a more pronounced damping characteristic, lower torque capacity and generally run more quietly than Oldham couplings. They also have a greater angular misalignment capacity, though this is only useable at low speeds.

Oldham-type couplings, though, are more robust and the replaceable wear element can be supplied in both heat and radiation resistant plastics. The hubs on the standard series are blind bored to a controlled depth, while the X-Y series couplings have through bores and have two-three times the backlash-free life. Torque discs are solid but can be specified with a bore to allow the passage of a shaft, although this will reduce the torsional stiffness of the coupling.

Both Uni-Lat and Oldham general-purpose couplings are suitable for position control. Specifically Uni-Lats are better suited to full and half step motor drives and Oldhams are suited to micro-stepper and closed loop systems.



Application Design Guide



Huco-Flex disc, bellows or multi beam couplings should be considered when:

1. Torsional stiffness is a critical parameter
2. The backlash-free life requirement is beyond the capacity of the Oldham or Uni-Lat
3. Speeds are typically higher than 3000 revs/min
4. Rotation is continuous or the duty-cycle exceeds 50%
5. A coupling with axial compliance is required to protect fragile bearings from thrust load
6. There is little risk of the alignment errors exceeding prescribed limits during initial installation or on subsequent replacement of the motor, encoder, etc.
7. The environmental conditions favor an all metal coupling

Although the life expectancy of the Huco-Flex bellows coupling is not as high as the comparable Huco-Flex disc coupling, size for size it offers the highest torsional stiffness ratio and provides a high level of translation accuracy. This makes the bellows-type coupling ideally suited to intermittent applications.

Huco-Flex disc couplings have a greater reliability and near infinite life when used within their torque and misalignment ratings. They also provide a high level of translational accuracy and their spring rates can be modified through varying the number and thickness of the stainless steel membranes.

However users must be aware that couplings designed around a flexural system can fail with little or no warning, causing immediate loss of drive. The cause of these failures is due mainly to metal fatigue caused by sustained flexure above the coupling's recommended torque and compliance factors.

Failure in mechanical couplings is more subjective and useful life can vary depending on individual applications. For instance, in zero backlash applications the coupling is deemed to have failed as soon as backlash is in evidence. In other applications the failure threshold may be 2 degrees of backlash.

Bore Reducers

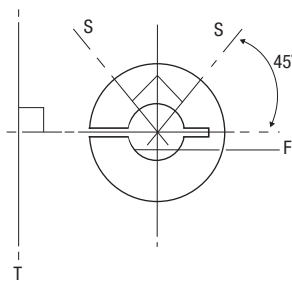
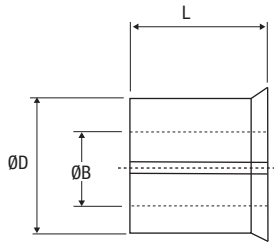

Bore for optimum fastening, install HUCOLOK bore adaptors as shown.

'S' represents screws in set screw hub.

'T' represents tangential screw in clamp hub.

'F' shows recommended orientation of flatted shaft in set screw hub.

The transmitted torque and concentricity may be affected when using adaptor. For best results shafts with h6 tolerance or better, are recommended. Undersized shafts become progressively less effective. For similar reasons, flatted shafts with more than 1/4 of their diameter removed are not recommended.

L	4.3	6.6	5.8	8.1	8.1	10.7	20
to fit bores coded	20	24	28	28	32	36	53
Outside Diameter ØD	5mm	1/4"	8mm	8mm	10mm	1/2"	1.00"
Bore Diameter ØB	Adaptor ref.						
2mm	251.11B	253.11B					
3mm	251.14B	253.14B	254.14B	255.14B			
.120"	251.15B	253.15B	254.15B	255.15B			
1/8"	251.16B	253.16B	254.16B	255.16B			
4mm	251.18B	253.18B	254.18B	255.18B	257.18B		
3/16"		253.19B	254.19B	255.19B	257.19B		
5mm		253.20B	254.20B	255.20B	257.20B	259.20B	
6mm			254.22B	255.22B	257.22B	259.22B	
1/4"					257.24B	259.24B	
7mm					257.25B	259.25B	
5/16"					257.27B	259.27B	
8mm					257.28B	259.28B	
9mm						259.30B	
3/8"						259.31B	262.31B
10mm						259.32B	262.32B
11mm							262.33B
12mm							262.35B
1/2"							262.36B
14mm							262.38B
15mm							262.40B
5/8"							262.41B
16mm							262.42B
18mm							262.45B
19mm							262.46B
3/4"							262.47B
20mm							262.48B
22mm							262.49B
7/8"							262.50B
24mm							
25mm							
1.00"							
material	brass				aluminum alloy		

Outside Diameter D is toleranced $-0.013 / -0.050\text{mm}$

Bore Diameter B is toleranced $+0.03 / -0\text{mm}$

Note: Short adaptor 254 is used with couplings as indicated in the standard bores tables. Use 255 for all other 8mm bores.

Other products available from Altra Industrial Motion



Clutches and Brakes

Warner Electric designed and patented the first electromagnetic clutch/brake over seventy years ago, and has led every major innovation since. Every product in Warner Electric's extensive offering is designed for long life, exceptional reliability, and low cost of operation. Models are available to meet the demands of applications throughout the world.



Enclosed Gear Drives

Boston Gear's comprehensive line of enclosed gear drives, including worm, in-line and parallel-shaft helical, miter, and bevel, provides the product variety you need to get the job done. Boston Gear's speed reducers are preferred by manufacturers worldwide. In fact, every time you specify a Boston Gear product, you incorporate quality, responsiveness, and Boston Gear's 123-year reputation into your design.



Electrically Released Brakes

Spring-set designs are available for stopping or holding a load in the event of a power failure; or choose permanent magnet designs for dynamic stopping or cycling moving loads. Choose from C-face, UniModule or Electro Module series brakes available in shaft mounted or flange mounted designs with a torque range from 35 lb. in. to 400 lb. ft.



Linear Guideways

World-class linear guideways from Warner Linear are engineered for long-lasting, trouble-free performance. Low friction design allows for smooth operation and low noise. Units provide reliability in high speed, high accuracy applications. Models are available for light, medium, heavy and super heavy loads.



Linear Actuators

Rugged, energy efficient A-Track linear actuators from Warner Electric have been carefully designed to provide long-lasting, maintenance free operation in light, moderate and heavy-duty applications both in-plant and mobile in all types of conditions worldwide. Models are available with Acme and Ball Screw drives to meet specific requirements.



Open Gearing

Boston Gear has been a leader and pioneer in manufacturing gearing products since 1877, when we introduced the concept of gear standardization and stock gears - innovations of enormous benefit to power transmission system designers, specifiers, and users. Today, Boston Gear manufactures a wide range of open gearing solutions to meet your specific needs.



Magnetic Headsets

The Precision Tork™ line of hysteresis capping clutches from Warner Electric, utilizes the most efficient torque control technology on the market to provide extremely smooth, consistent application of torque with less adjustment and downtime.



Bearing Products

When you want the freedom to select from the widest range of the highest quality bearings, come to the power transmission specialists at Boston Gear. Everything from plain sleeve bearings, ball bearings, rod ends, and spherical bearings to linear bearings, pillow blocks and flanged units are in stock.



Electrical Products

From fractional horsepower AC and DC motor controllers to a complete offering of complementary motors, Boston Gear is prepared to meet the broad spectrum of your adjustable speed needs.

ALTRA INDUSTRIAL MOTION

Warner Electric

Electromagnetic Clutches and Brakes - USA

South Beloit, IL
815-389-3771

For application assistance:
1-800-825-9050

Electromagnetic Clutches and Brakes - Europe

St Barthelemy d'Anjou, France
+33 (0)2 41 21 24 24

For sales office:
+33 (0)2 41 21 24 76

Precision Electric Coils and Electromagnetic Clutches and Brakes - USA

Columbia City, IN
260-244-6183

Inertia Dynamics

Spring Set Brakes; Power On and Wrap Spring Clutch/Brakes

Torrington, CT
860-482-4444

Matrix International

Electromagnetic Clutches and Brakes, Pressure Operated Clutches and Brakes

Brechin, Scotland
+44 (0) 1356 602000

U.S.
815-389-3771

Warner Linear

Linear Actuators and Guideways - USA

Belvidere, IL
815-547-1106

For application assistance:
1-800-825-9050

TB Wood's

V-Belt Drives, Synchronous Drives, Flexible Couplings, Variable Frequency AC Drives

Chambersburg, PA
717-264-7161

For assistance:
1-888-829-6637
Press #5 – Customer Service
Press #7 – Mechanical Applications
Press #8 – Electronic Applications

Wichita Clutch and Industrial Clutch

Pneumatic and Oil Immersed Clutches and Brakes - USA

Wichita Falls, TX
940-723-3400

Pneumatic Clutches and Brakes - Europe

Bedford, England
+44 (0)1234 350311

Twiflex Limited

Caliper Brakes and Thrusters

Twickenham, England
+44 (0) 20 8894 1161

Formsprag Clutch

Overrunning Clutches and Holdbacks

Warren, MI
586-758-5000

For application assistance:
1-800-927-3262

Marland Clutch

Roller Ramp and Sprag Type Overrunning Clutches and Backstops

Burr Ridge, IL
630-455-1752

Stieber Clutch

Overrunning Clutches and Holdbacks

Heidelberg, Germany
+49 (0)6221 30 47 0

Boston Gear

Enclosed and Open Gearing, Electrical and Mechanical P.T. Components

Charlotte, NC
704-688-7300

For customer service:
1-800-825-6544

For application assistance:
1-800-816-5608

Huco Dynatork

Precision Couplings and Air Motors

Hertford, England
+44 (0) 1992 501900

U.S.
800-825-6544

Ameridrives Couplings

Gear Couplings, Mill Spindles, Universal Joints

Erie, PA
814-480-5000

Bibby Transmissions

Disc, Gear, Grid Couplings, Overload Clutches

Dewsbury, England
+44 (0) 1924 460801

Nuttall Gear and Delroyd Worm Gear

Worm Gear and Helical Speed Reducers

Niagara Falls, NY
716-298-4100

Saftek Friction

Non-asbestos Brake and Clutch Materials

Telford, England
+44 (0) 1952 581122

Altra Industrial Motion - Asia Pacific and Africa

China 852 2615 9313

Taiwan 886 2 2577 8156

Singapore 65 6487 4464

Thailand 66 2 322 5527

Australia 612 9894 0133

S. Africa 27 11 918 4270



www.bostongear.com



701 Carrier Drive • Charlotte, NC 28216
www.bostongear.com
Customer Service: 800-825-6544
An Altra Industrial Motion Company